

Kingdom of Saudi Arabia
Ministry of Higher Education
King Faisal University
College of Clinical Pharmacy



Standard Operating Procedures for Instruments

2012

King Faisal University
College of Clinical Pharmacy
PO Box 400, Al-Ahsa 31982
Kingdom of Saudi Arabia

Kingdom of Saudi Arabia
Ministry of Higher Education
King Faisal University
College of Clinical Pharmacy



Standard Operating Procedures for Instruments



Table of Contents

Sl. No.	Particulars	Page Number
1.	Introduction.....	3
2.	College Vision, Mission, Values and Goals.....	4
3.	Program Mission, Goals and outcomes.....	5
4.	Standard Operating Procedure.....	6-134
i.	<i>Atomic absorption Spectrophotometer.....</i>	6
ii.	<i>CHN Analyzer.....</i>	10
iii.	<i>Differential Scanning Calorimeter.....</i>	15
iv.	<i>Disintegration Apparatus.....</i>	28
v.	<i>Dissolution Apparatus.....</i>	32
vi.	<i>Freeze Dryer.....</i>	35
vii.	<i>Fourier Transform Infrared spectroscopy.....</i>	39
viii.	<i>Flying spot Scanning Densitometer.....</i>	44
ix.	<i>Gas Chromatography Mass spectrometer.....</i>	47
x.	<i>High Performance Liquid Chromatography.....</i>	53
xi.	<i>Liquid Chromatography Mass spectrometer.....</i>	57
xii.	<i>Microscope.....</i>	61
xiii.	<i>NMR spectrometer.....</i>	65
xiv.	<i>Nano Spray Dryer.....</i>	70
xv.	<i>Serum Protein Electrophoresis.....</i>	82
xvi.	<i>Spectrofluorophotometer.....</i>	85
xvii.	<i>Spectrophotometer.....</i>	89
xviii.	<i>Soxtec Extraction Unit.....</i>	93
xix.	<i>Suppository Hardness Tester.....</i>	101
xx.	<i>Tablet Abrasion and Friability Tester.....</i>	104
xxi.	<i>Tablet Thickness Tester.....</i>	111
xxii.	<i>Tablet Thickness, Weight, Diameter and Hardness Tester.....</i>	114
xxiii.	<i>Tapped Density Tester.....</i>	123
xxiv.	<i>Thermal Cyclor.....</i>	126
xxv.	<i>Zetasizer.....</i>	129

INTRODUCTION

The Standard Operating Procedures (SOPs) for instruments, include the standard protocol to be followed for the proper and efficient functioning of instruments during the operation by students, faculty, lab technicians and other researchers of the university / college.

The following elements are included in the SOPs.

- 1. Objective:** Describe the purpose of the process or procedure.
- 2. Scope:** Express the applications of the process or procedure and any organization or regulatory requirements, as well as any limits to the use of the procedure.
- 3. Responsibilities:** Denotes the individual's responsibility and minimum experience the user should have to use the instrument satisfactorily.
- 4. References:** Cited references used for preparing these SOP's and for further detailed information.
- 5. Definitions:** Any acronyms, abbreviations, or specialized terms used are defined in this segment.
- 6. Precautions:** Indicate the activities which could result in equipment damage, degradation of sample or possible invalidation of results and critical steps in the procedure.
- 7. Procedure:** All pertinent steps to be followed are described in sequence along with the materials required to accomplish the goal.

Each student, faculty, lab technician or any researcher handling the instruments is expected to read and be familiar with each section of the SOP. This is intended to be a dynamic document and will be revised periodically . Mention of trade names or commercial products does not constitute endorsement or recommendation for use.

VISION OF THE COLLEGE

"To be recognized nationally and internationally for preparing role models in Pharmacy practice, education and research, through commitment to community engagement".

MISSION OF THE COLLEGE

"To excel in pharmacy education, patient centered care, community engagement and research"

VALUES

Based on Islamic Principles, the College of Clinical Pharmacy promotes an environment of mutual respect and collaboration, where we value:

- ✓ *Excellence : Pursue exceptional quality and performance in all that we do*
- ✓ *Responsiveness to community*
- ✓ *Lifelong, self-directed learning*
- ✓ *Creativity*
- ✓ *Integrity: at all levels of teaching, training, research and patient care.*

COLLEGE STRATEGIC GOALS

1. Prepare Pharm D graduates through excellence in Pharmacy education and training
2. Recruit, develop and retain internationally recognized, competent faculty members in all the disciplines
3. Continue to develop administration that will provide leadership for achieving strategic goals
4. Maintain and enhance the quality assurance management, verified through accreditation by National and International Accrediting agencies in Pharmacy Education
5. Engage the local, national and international communities for mutual benefits through expanding the opportunities for collaboration, continuing professional development and postgraduate education
6. Conduct exceptional research in basic and clinical sciences.

PROGRAM MISSION (Pharm.D.)

"To Prepare Pharm D graduates who will provide patient centered care to meet the needs of the community"

PROGRAM GOALS

1. Prepare active learners and future experts in Clinical Pharmacy with required knowledge, skills and abilities
2. Educate for management of Pharmacy services and practice
3. Provide foundation for basic and clinical research in the area of drug development and usage

PROGRAM OUTCOMES

After completion of the program, the graduate will be able to

1. Apply fundamental scientific knowledge and principles as basis of Pharmaceutical and Clinical Sciences.
2. Apply knowledge of biomedical sciences for understanding of disease process and its diagnosis.
3. Develop patient data base from patient interview, review hospital record and communication with other health professionals.
4. Apply knowledge of clinical Sciences in designing patient specific therapeutic plan based on best evidence and counseling the patient regarding it.
5. Retrieve, interpret and report drug information from pharmaceutical and biomedical science resources and apply information to specific patient care situation.
6. Recognize basic principles of drug development, formulation and bioequivalence studies to contribute in pharmaceutical industry and in research institutes.
7. Appreciate necessary knowledge in organizational and administrative domains for management of Pharmaceutical services and practice.
8. Recognize basic principles to design, implement and conduct research studies in different fields of pharmacy practice.

1. SOP FOR ATOMIC ABSORPTION SPECTROPHOTOMETER

	Prepared by		
Document Number	Name	Signature	Date
CCP001	Dr. Mahesh Attimarad Assistant Professor, Department of Pharmaceutical Sciences, College of Clinical Pharmacy, KFU		
Revision Number	Approved by		
R0	Dr. Ibrahim Alhaider Dean, Department of Pharmaceutical Sciences, College of Clinical Pharmacy, KFU		

Document History

Document Section	Details of Amendments	Date	Modified by (Initials)
SOPs	First Draft on SOP for the operation of Shimadzu Atomic Absorption Spectrophotometer	/ /2011	Dr. Mahesh

1. OBJECTIVE

The following document describes the procedure on the operation of Shimadzu Atomic Absorption Spectrophotometer (AAS).

2. SCOPE

Atomic absorption spectroscopy (AAS) is a spectroanalytical procedure for the qualitative and quantitative determination of chemical elements employing the absorption of optical radiation (light) by free atoms in the gaseous state. In analytical chemistry the technique is used for determining the concentration of a particular element (the analyte) in a sample to be analyzed. AAS can be used to determine over 70 different elements in solution or directly in solid samples.

3. RESPONSIBILITIES

- ❖ It is the responsibility of designated personnel in Research lab to train staff and students on this procedure and to ensure adherence to this procedure.

- ❖ It is the responsibility of designated personnel (staff or Student) to follow the instructions of this procedure.

4. REFERENCES

- ❖ AA-6300 Instruction Manual (Operation Guide) for Shimadzu Atomic Absorption Spectrophotometer.
- ❖ Installation Procedure of WizAard control software for Shimadzu Atomic Absorption Spectrophotometer.

5. DEFINITIONS

- ❖ Blank solution: Solution having only reagents, used for eliminating absorption by reagents.
- ❖ STD: Standard solutions

6. PRECAUTIONS

- ❖ Don't open the flame window when flame is on.
- ❖ Do not leave without closing the acetylene tank when not in use. acetylene is explosive and quite dangerous.

7. PROCEDURE FOR OPERATING THE AA SPECTROPHOTOMETER

7.1. Turning on the AAS

- ❖ Turn on the computer, Double click on the "WizAard" shortcut on the desktop.
- ❖ The "Operation" tab should be highlighted. Click on the picture of the AAS.
- ❖ Enter "admin" for the user id and hit "ok". (No password)
- ❖ The program opens with wizard selection.
- ❖ Select the " element selection" Icon and press OK.
- ❖ Element selection window will appear .
- ❖ First click on the "select Element" Than load parameters will appear.
- ❖ In this select the required element eg.: K(potassium) and press OK and then finish.
- ❖ Make sure that the Acetylene gas line pressure should be between 12 and 14 psi.
- ❖ Turn on the AAS. (Power switch is on the front, lower right corner of the instrument.)
- ❖ From instrument drop down menu select the "Connect/Send Parameters" button. The program will proceed through an initialization checklist. When the program asks if you would like to test the safety parameters, click "no" and then "ok". (You will need to do this 3 times. We run though all of the safety checks once a week.)
- ❖ Instrument check list for Flame analysis will open. Tick all the boxes and press OK.

- ❖ Igniting flame. Simultaneously press two buttons, ignite and Purge. The burner head will ignite.

7.2. Software Operation.

- ❖ Open the main screen of the WizAard program.

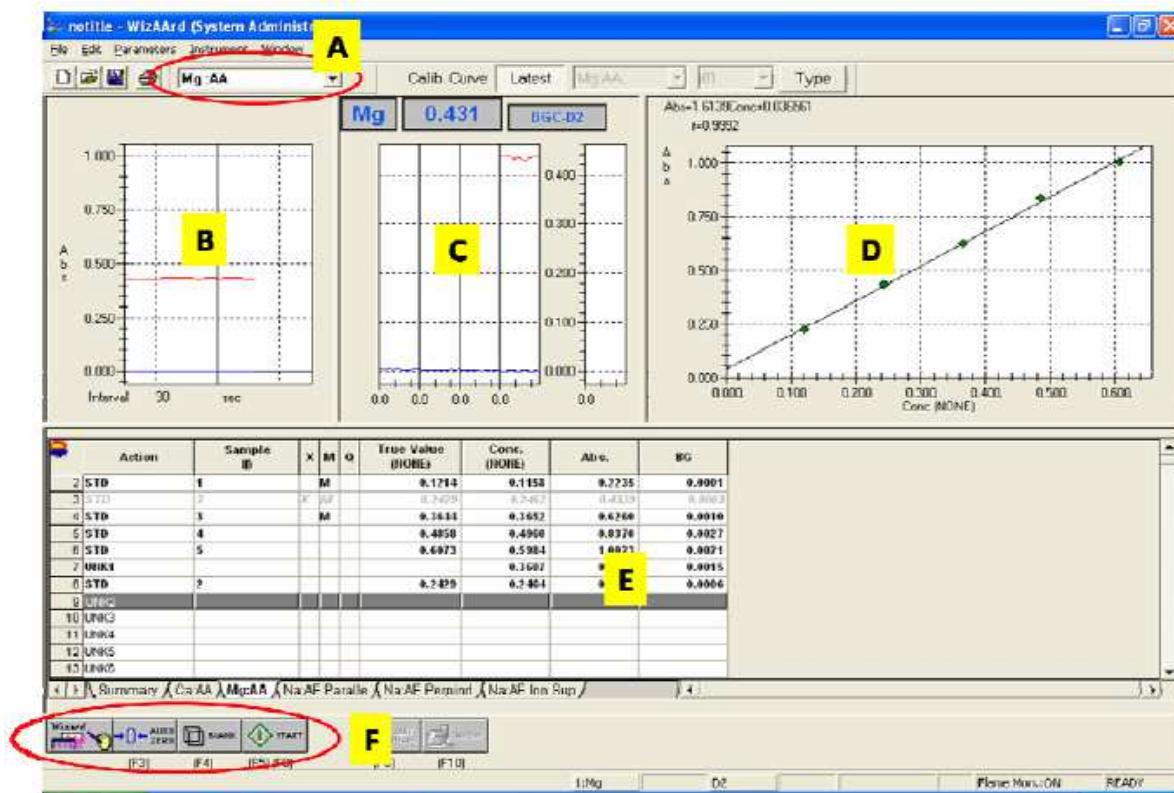

- ❖ Element selection (A): Use this dropdown box Parameters to select which element you are working with.
- ❖ From the Parameters drop down menu select Edit Parameters and then click on “Line Search. This usually takes a few minutes. When the line search finishes, a spectrum will appear with a red line crossing at the maximum. If the red line is not at the maximum, run the line search again.
- ❖ When this finishes, hit “Close”. and press OK on Edit parameter window.

7.3. Data Collection

- ❖ AUTO ZERO, BLANK AND COLLECT DATA. Place the suction tube in DI water. Watch the Absorbance vs. time plot in the upper left corner of the screen (B). When the Abs level has stabilized, click on the “Auto Zero” button(F).

- ❖ Place the suction tube in your “0” concentration (blank) standard. When the Abs level has stabilized, click the “blank” button.
- ❖ Measure the absorbance of standards and unknowns according to the rows .
- ❖ To do this select STD in the first column, and press ok and place the suction nozzle in one of the solutions and aspirate. Once the Abs level has stabilized, click on the “Start” button. The instrument will wait 5 seconds and then collect data for 5 seconds (C). The results will then be displayed in the Measurement Results Table (E) (MRT).
- ❖ Repeat step 4 for all the std solutions. Check the calibration curve displayed on the right upper of the window (D).
- ❖ To measure the sample in the MRT select UNK and than repeat step 4.
- ❖ Note down the concentration of unknown solution from MRT.

7.4. To turn off the instrument.

- ❖ Press the “Extinguish” button on the front of the instrument.
- ❖ Close the main tank valve on the acetylene tank.
- ❖ Purge the line of acetylene by pressing the “Purge” button.
- ❖ Close the air valve which is below the bench.
- ❖ Make sure that both the meters are showing zero reading (One on the acetylene gas cylinder and one below the bench of AA instrument).
- ❖ Turn off the power to the AAS. Exit out of the software.

**NOTE: DO NOT LEAVE WITHOUT CLOSING THE ACETYLENE TANK.
ACETYLENE IS EXPLOSIVE AND QUITE DANGEROUS.**

End of Document

2. SOP FOR CHNS ANALYZER

	Prepared by		
Document Number	Name	Signature	Date
CCP002	Dr. Mahesh Attimarad Assistant Professor, Department of Pharmaceutical Sciences, College of Clinical Pharmacy, KFU		
Revision Number	Approved by		
R0	Dr. Ibrahim Alhaider Dean, Department of Pharmaceutical Sciences, College of Clinical Pharmacy, KFU		

Document History

Document Section	Details of Amendments	Date	Modified by (Initials)
SOPs -	First Draft on SOP for the operation of Eurovector CHNS analyzer	/ /2011	Dr. Mahesh

1. OBJECTIVE

- ❖ The following document describes the procedure on the operation of CHNS analyzer.

2. SCOPE

- ❖ **CHN Analyzer** is a scientific instrument which can determine the elemental composition of a samples such as organic and inorganic compounds.
- ❖ This instrument is used for qualitative and quantitative analysis of elements (CHNS) in pharmaceuticals.

3. RESPONSIBILITIES

- ❖ It is the responsibility of designated personnel in Research lab to train staff and students on this procedure and to ensure adherence to this procedure.
- ❖ It is the responsibility of designated personnel (staff or Student) to follow the instructions of this procedure.

4. REFERENCES

- ❖ EuroEA 3000 series – installation Procedure for CHNS
- ❖ Eurovector instruments and software Callidus Software Interface Version 5.1.

5. DEFINITIONS

- ❖ Bypass: Un-weighed standard samples are introduced to clean and condition the entire analytical circuit prior to sample analysis.

6. PRECAUTIONS

- ❖ Each time leak test has to be performed.
- ❖ You must not proceed data acquisition until the leak test has passed.

7. PROCEDURE FOR OPERATING THE AA SPECTROFLUOROPHOTOMETER

❖ Starting the Instrument

- ❖ Open the valves of the Helium and Oxygen gas cylinder and set the pressure to 4 bar (60 psi),
- ❖ Turn on the instrument, The on/off switch is located at the rear of the instrument.
- ❖ Turn on the computer and to Start the software, Double click the icon Callidus software.

❖ Soft ware Operation.

- ❖ From the main menu click Operator login.
- ❖ Enter user name =EVR and Password = EA3000 and click on the OK button.
- ❖ Create method for CHNS
- ❖ From the main menu select Instrument Setting.
- ❖ In the method frame type the instrument parameters as reported in the Analytical Protocol received with EA.
- ❖ Press the save as button to store the parameters in the methods library.
- ❖ Click on the send button to load the new parameters on the instrument. The front furnace and GC oven will star to heat up immediately.
- ❖ Wait for the instrument to condition , until the instrument status shows READY.



❖ Performing the Leak test

- ❖ Click on the Instrument menu from the menu bar.

- ❖ Select Leak test from the drop down list
- ❖ Click on the START leak test Button.
- ❖ The result is displayed in the label reporting passed or failed.
- ❖ You must not proceed until the leak test has passed.
- ❖ **Setting Auto run Window**
 - ❖ Click on Analysis on the menu bar
 - ❖ Select New autorun from the drop down menu
 - ❖ Fill the sample table

Sample Table

Pos.	Sample Name	Type	W (mg)
1	L-Cystine-1	Std	0.5610
2	L-Cystine-2	Std	1.0560
3	L-Cystine-3	Std	1.4520
4	Sample-4	Smp	0.7010
5	Sample-5	Smp	0.8360
6	Sample-6	Smp	1.2210

Method

Parameter	Applied	Set to
Carrier	80 kPa	80
Purge	80 ml/min	80
Oxygen	20 ml	20
ΔP O ₂	35 kPa	35
Oxidation time	8.7 sec	8.7
Sample Delay	10 sec	10
Run time	320 sec	320
Front Furnace	1020 °C	1020
Rear Furnace	OFF °C	OFF
GC Oven	115 °C	115

Report Configuration

CHNS Configuration

Additional Information: 1000

Print options:

- Default reports
- Custom
- All reports
- No reports

Data Processing

Calibration Type: K-Factor Linear

Component Table:

Element	N	C	H	O
Retention time (s)	33	50	114	201
Window (±s)	3	10	46	40
Interval from (s)	-	-	-	-
Integration to (s)	-	-	-	-

Integration Parameters

Start Integr.	Peak Thr.	Peak Width	Min. Area	Baseline
1	1	1	1000	V.Valley

Time Event Functions

From	To	En.Int.	PT	PW	MA	Bsl

Autorun

Save Import Load

Start

Stand-by at the end of Autorun

- ❖ **Balance Interface : automatic transfer of weights**
 - ❖ Connect the balance cable to COM part #2 of your computer.
 - ❖ Prepare the sample table without entering weights for standards and samples.
 - ❖ Click the balance button below the sample table.
 - ❖ Click on the sample table the row of the position to which the weight must be transferred.
 - ❖ Weigh the sample and wait for balance stability, then press the transfer button of the balance.
 - ❖ The transferred weight appears in the sample table at the active cell.
 - ❖ The process is repeated with each subsequent standard and sample.

- ❖ **Naming Auto run**
 - ❖ Click on the save button in the autorun frame
 - ❖ Creat new autorun name window opens
 - ❖ Click add type, Type new name and click OK.
- ❖ **Running an Experiment**
 - ❖ When all the settings have been made in the Autorun window, press Send to instrument.
 - ❖ When monitor window bar shows **READY** press **START**.
 - ❖ The acquisition window appears and acquisition starts.
- ❖ **Viewing the acquired Chromatograms and Results.**
 - ❖ Click the acquired samples button in the Acquisition window
 - ❖ Click the desired sample Table line.
 - ❖ The results window reports the % element.

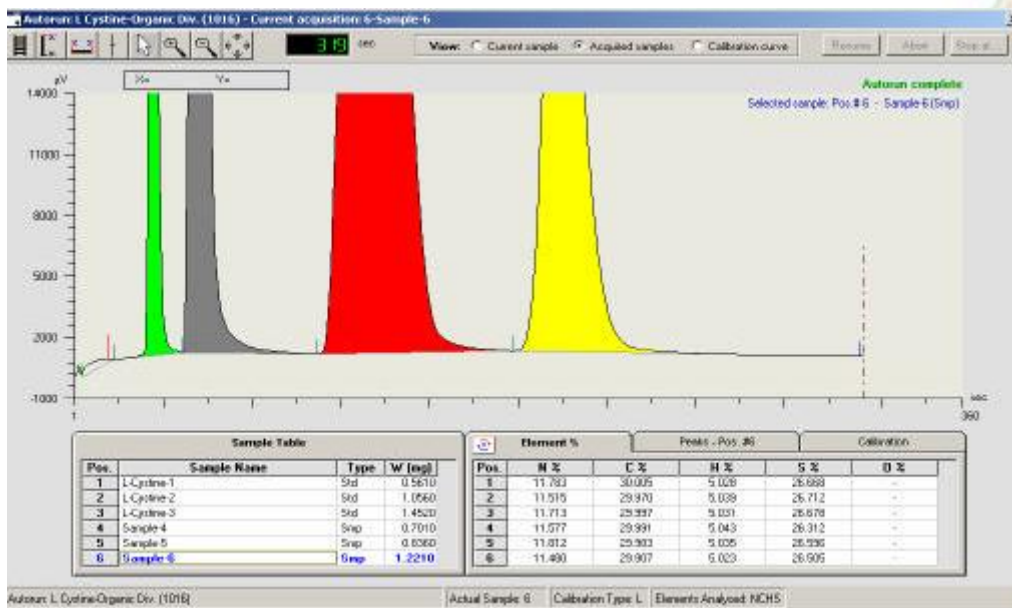

- ❖ **Shutting down the instrument**
 - ❖ Click on Operator on the main menu
 - ❖ Select Exit Callidus
 - ❖ Than press OK
 - ❖ Turn off instrument

- ❖ Close the gas cylinder valves.

End of Document



3. SOP FOR DIFFERENTIAL SCANNING CALORIMETRY (DSC)

	Prepared by		
Document Number	Name	Signature	Date
CCP003	Dr. Sree Harsha Assistant Professor, Department of Pharmaceutical Sciences, College of Clinical Pharmacy, KFU		
Revision Number	Approved by		
R0	Dr. Arshia Shariff Asst. Professor, Department of Pharmaceutical Sciences, College of Clinical Pharmacy, KFU		

Document History

Document Section	Details of Amendments	Date	Modified by (Initials)
SOPs -	First Draft on SOP for the operation of Differential Scanning Calorimetry (DSC)	/ /2011	Dr. Harsha

1. OBJECTIVE

Differential scanning calorimetry (DSC) monitors heat effects associated with phase transitions and chemical reactions as a function of temperature. In a DSC the difference in heat flow to the sample and a reference at the same temperature, is recorded as a function of temperature. The sample is sealed in an aluminum pan. The reference is an inert material such as alumina, or just an empty aluminum pan. The temperature of both the sample and reference are increased at a constant rate.

2. SCOPE

The Perkin-Elmer DSC-7 differential scanning calorimeter is used to accurately measure melting points, glass transitions, and heats of fusion.

3. RESPONSIBILITIES

It is the responsibility of designated personnel in Research lab to train staff and students on this procedure and to ensure adherence to this procedure.

It is the responsibility of designated personnel (staff or Student) to follow the instructions of this procedure.

4. REFERENCES

Differential Scanning Calorimetry (DSC) Instruction Manual (Operation Guide)

5. DEFINITIONS

Nil

6. PRECAUTIONS

- **Never touch the outer and inner furnace lids. The temperature of the furnace can reach as high as 450°C. Use tweezers to remove the lids**
- **Do not touch the inside of the furnace; it might be hot and internal pollution can cause loss of performance**

7. PROCEDURE FOR OPERATING THE AA SPECTROPHOTOMETER

- ❖ Turn on the power switch on the front of the DSC.



Turn ON the power switch for the DSC.

- ❖ Log into Windows
- ❖ After Windows comes up, double-click the LOG ON icon. The LOG ON window will come up. Type in your username & password.



- ❖ After you login, the Pyris software will load. You will see a menu bar at the top of the screen, which will indicate that the DSC 7 is Offline. Click on the DSC 7 icon to bring it online:



Click on the DSC 7 icon

- ❖ The DSC 7 window will come up.

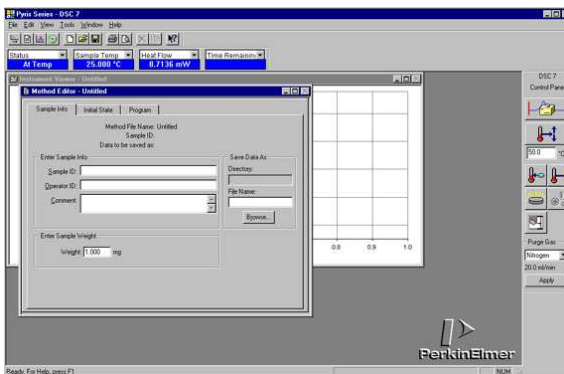

- ❖ You should see temperature status information for the TGA 7 if everything is working properly:

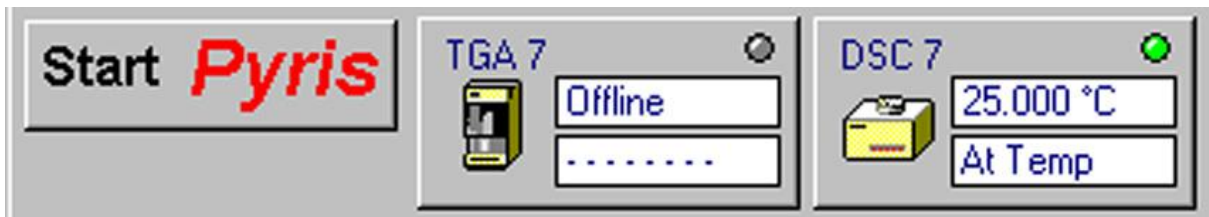

- ❖ Fill the DSC with ice water, with the metal funnel in place.



- ❖ First, we need to run a blank spectrum to verify that the DSC was found in good condition. After you run your blank spectrum, print it out, and put your name on it and place it in the tray by the computer monitor. Before you run the blank, check to make sure that both the sample and reference furnaces are empty.

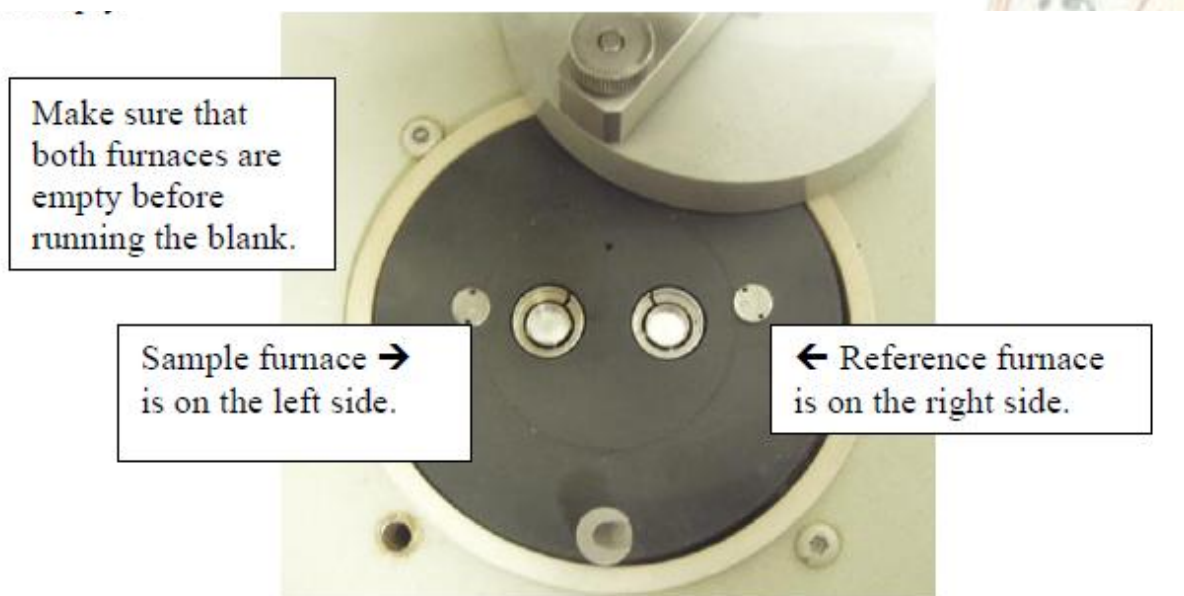

- ❖ After you have checked that both furnaces are empty, put their platinum lids on, close the swing-arm cover, and put the dome on top.

Dome cover is shown in place over the furnace assembly.



- 10) Set up your data acquisition using the method editor.

The screenshot shows the 'Method Editor - Untitled' window. It has three tabs: 'Sample Info', 'Initial State', and 'Program'. The 'Sample Info' tab is active. The window contains the following fields and controls:

- Method File Name: Untitled
- Sample ID: Blank run
- Data to be saved as: blank_11-11-09.dad
- Enter Sample Info section:
 - Sample ID: [Blank run]
 - Operator ID: [jwinda]
 - Comment: []
- Save Data As section:
 - Directory: [E:\jwinda]
 - File Name: [blank_11-11-09.dad]
 - Browse... button
- Enter Sample Weight section:
 - Weight: [1.000] mg

Annotations with arrows point to the following elements:

- 'Sample Info tab →' points to the 'Sample Info' tab.
- 'Enter sample ID information here →' points to the 'Sample ID' field.
- '← Click on Browse to navigate to the folder you want to put the data in, and to give it a filename.' points to the 'Browse...' button.
- A text box at the bottom left states: 'For the blank run, you do not need to enter anything for the sample weight. For an actual sample, you must enter its weight if you want to measure ΔH .'



Initial State tab →

Set initial temp here →
50 C for the blank run

Set Y baseline here →

Program tab →

For the blank run, set the final temp to 400 C →

For the blank run, set the heating rate to 40 C/min →

← Adjust the total points in the run to something reasonable, such as 1 point per degree C.

- ❖ Set the DSC to the starting temperature in your run.
- ❖ Set the DSC to the starting temperature in your run.
- ❖ Set the DSC to the starting temperature in your run.

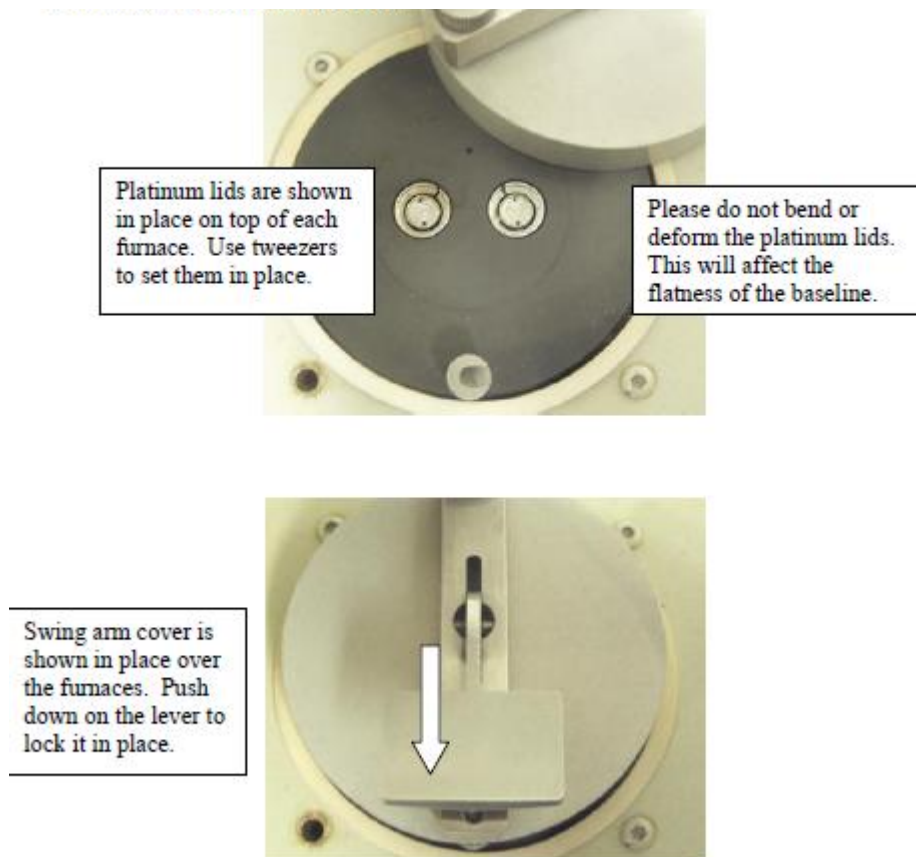

- ❖ Set the DSC to the starting temperature in your run.

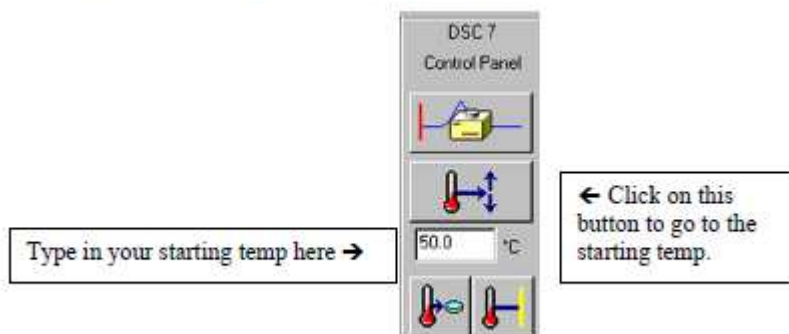

- ❖ After the DSC status indicates that is “At Temp”, look at the Heat Flow reading, and wait until the Heat Flow is stable to 0.001 mW.



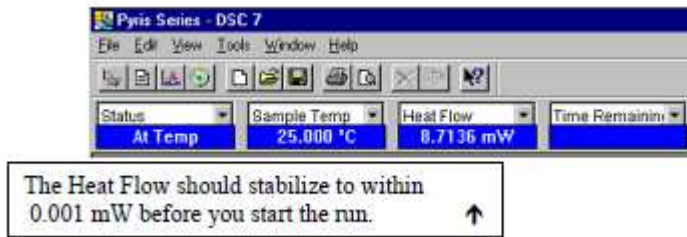

- ❖ Start the run by clicking on the Start Run button.

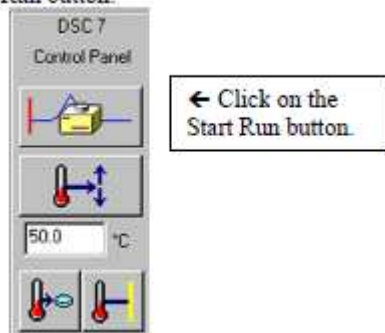

- ❖ After the run has started, click on the Instrument Viewer to monitor the progress of the run.
- ❖ Note that the default setting for the graph is to have “Time” displayed on the X-axis. If you want to change this to Temperature, click on the Display menu, and click on Rescale X, and you will see an option to change the X-axis to Temperature
- ❖ Please print out your blank spectrum, and put your name on it, and place it in the tray next to the computer monitor.

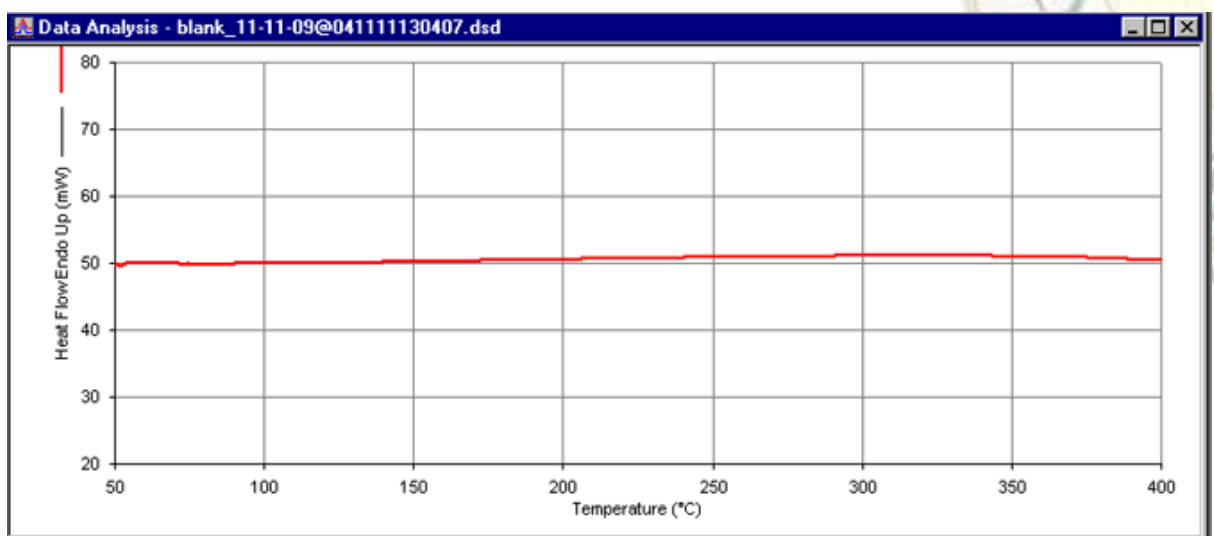

❖

- ❖ To run an actual sample, you must first encapsulate your sample in a special aluminum sample pan. For instructions on how to do this, please see the Appendix on sample preparation. Place your sample pan into the middle of the sample furnace, and then put an empty aluminum pan into the reference furnace.



- ❖ Carefully put the platinum lids on top of each furnace, then secure the swing-arm cover over the furnaces, and then put the dome lid on top.

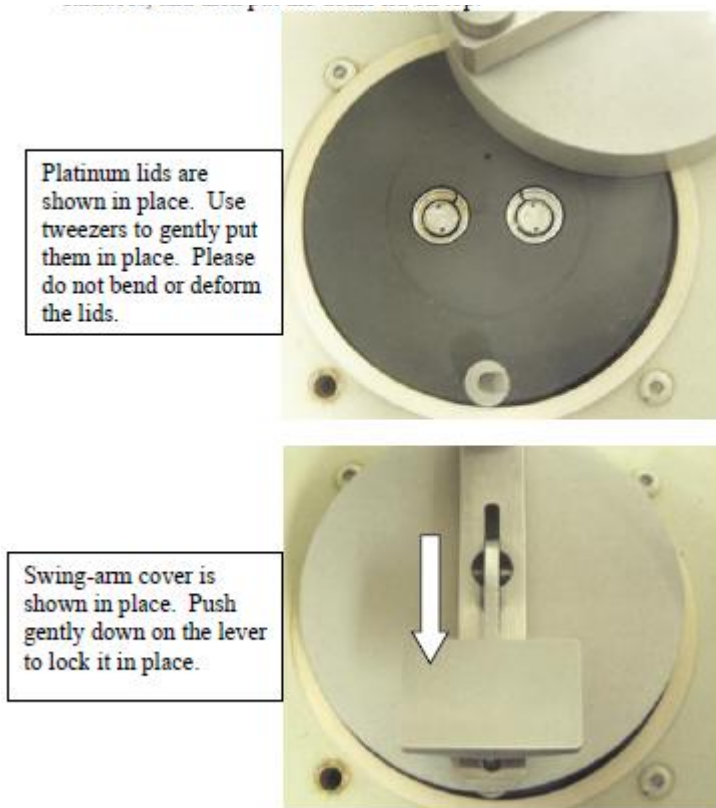

Dome cover is shown in place.

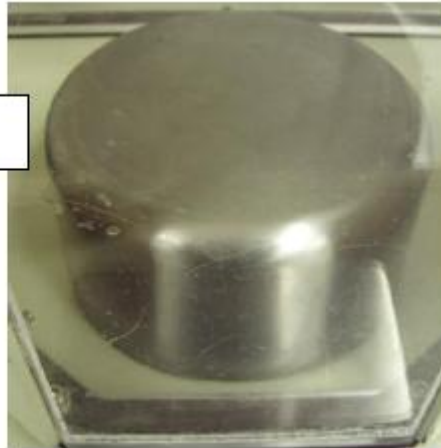

- ❖ Set up your data acquisition using the method editor

Sample Info tab →

Enter sample ID information here. →

Enter an accurate sample weight here, if you want to measure ΔH .

← Click on Browse to navigate to the folder you want to put the data in, and to give it a filename.

- ❖ Tell the DSC to go to your starting temperature

- ❖ When it is “At Temp”, monitor the Heat Flow. Wait until the Heat Flow is stable to 0.001 mW. Then click on the Start Run button.



- ❖ Click on the Start Run button.

- ❖ To monitor the progress of the run, you can click on the Instrument Viewer window.

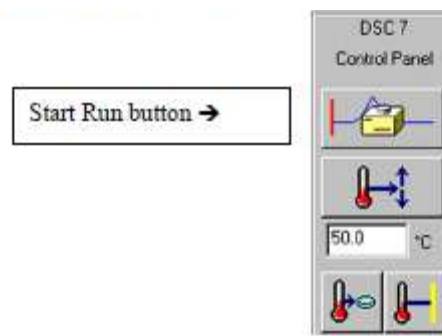

- ❖ DSC Data Analysis

- ❖ To calculate the onset temperature, peak area, and enthalpy, click on the Calc menu, and click on Peak Area. Click on the option to include Onset. Position the X's at the start of the peak, and at the end of the peak. Then click on Calculate

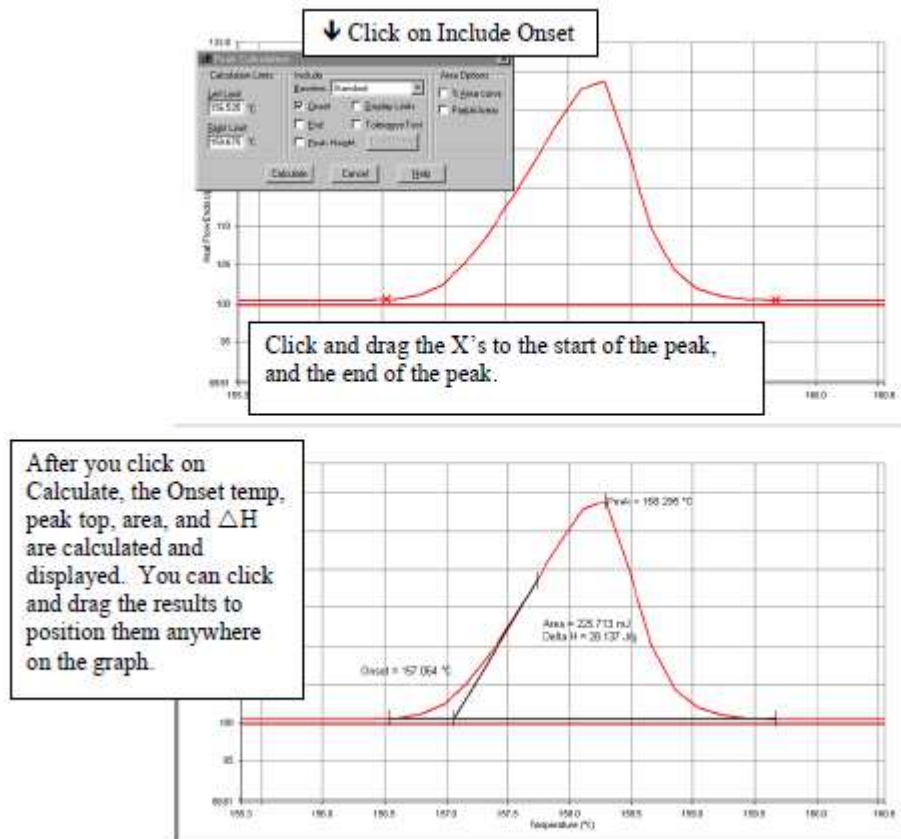

- ❖ You must then click on File, and Save Data, in order to save the calculated results with the raw data file.
- ❖ To convert a spectrum to ASCII format, click on the Edit menu, and click on Copy. Then go to a text program such as Word, and click on Edit and Paste. The sample data points and the acquisition parameters will be displayed in text format, and can then be saved.
- ❖ **How to shut down the DSC**

- ❖ First, run another blank spectrum to show that you have left the DSC in good condition. Please print out the blank graph, put your name on it, and put it in the tray near the computer monitor.
- ❖ Click on the Start Pyris button, and then click on Close All. This will close the software.

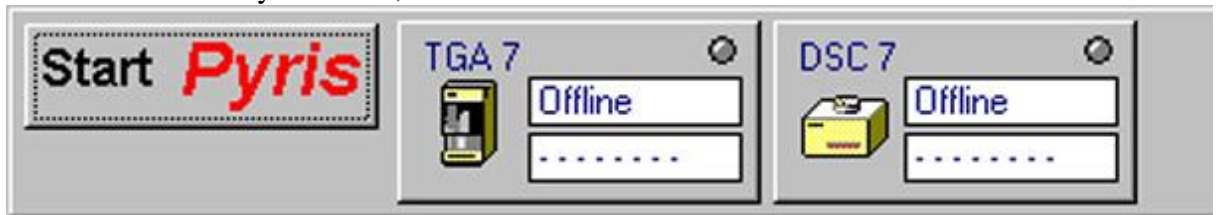

- ❖ Log out of Windows.
- ❖ Turn off the DSC TAC (Thermal Analysis Controller).



- ❖ Turn off the power switch on the DSC.



- ❖ Turn off the nitrogen gas.



End of Document

4. SOP FOR DISINTEGRATION APPARATUS

	Prepared by		
Document Number	Name	Signature	Date
CCP004	Dr. Azza Ali Hasan Assistant Professor, Department of Pharmaceutical Sciences, College of Clinical Pharmacy, KFU		
Revision Number	Approved by		
R0	Dr. Ibrahim Alhaider Dean, Department of Pharmaceutical Sciences, College of Clinical Pharmacy, KFU		

Document History

Document Section	Details of Amendments	Date	Modified by (Initials)
SOPs -	First Draft on SOP for the operation of Disintegration apparatus	/ /2011	Dr. Azza

1. OBJECTIVE

The following document describes the procedure on the operation of Disintegration apparatus.

2. SCOPE

The Disintegration apparatus used to explore disintegration mechanism and times of rapidly disintegrating tablets

3. RESPONSIBILITIES

- ❖ It is the responsibility of designated personnel in Research lab to train staff and students on this procedure and to ensure adherence to this procedure.
- ❖ It is the responsibility of designated personnel (staff or Student) to follow the instructions of this procedure.

4. REFERENCES

Instruction Manual (Operation Guide) Erweka Company for disintegration apparatus.

5. DEFINITIONS

The Erweka disintegration tester is a 2-basket system.

6. PRECAUTIONS

If the equipment is used in a manner not specified by the manufacturer, the protection provided by the equipment may be impaired.

7. PROCEDURE FOR OPERATING THE DISINTEGRATION APPARATUS

- ❖ Ensure the calibration status is valid and make sure that the instrument is clean and free from dust.
- ❖ Switch on the main switch and put on the 'ON/OFF' switch at the rear panel to 'ON' position Follow the procedure to set the temperature.
- ❖ For setting the temperature select the BATH probe by pressing PROBE key.
- ❖ This key toggles between BATH probe EXTSEL.
Press SET key – LED to the right of the key will glow.
Press TEMP key- Temperature display shows previous set temperature with right most digit flashing.
- ❖ Press ▲ key –Flashing digit value will show increment for every key press. OR
Press ▼ key - Flashing digit value will show decrement for every key press. Set the value for flashing digit.
- ❖ Press DISP key - Next significant digit flashes .Repeat the above step.
- ❖ Repeat the step c & d till the desired temperature is set.
- ❖ Press ENTER key –Set temperature value will be registered and SET LED will be off.
- ❖ To confirm the set value of temperature, press SET key first and TEMP key next. See the set value. Press ENTER key to come out from set mode.
NOTE: After pressing the SET key one should start the settings within 10 seconds otherwise the set mode will be terminated automatically.
- ❖ Press the TEMP key to start temperature controller. The LED above TEMP key will start glowing.
- ❖ Select the bath temp indicator using PROBE SEL key. Once the bath temperature reaches the set value , you are ready to start the test by pressing START/STOP key.

8. There are two modes of operation.

❖ Timer mode b) Manual mode

- a) Select mode by pressing TIMER key, if the TIMER LED is on, then timer mode is selected. If the TIMER LED is off & Timer display shows “.....” then manual mode is selected. TIMER key toggles between TIMER mode and
- ❖ MANUAL MODE.
 - ❖ In timer mode two time ranges are possible.
 - ❖ 1 sec to 99 min & 59 sec.
 - ❖ 1 min to 9 hrs & 59 min (if this range is selected the forth (left most) digit of timer display will show “....”).
 - ❖ For changing the timer range press SET key first and the ENTER key. Once the test is started range cannot be altered.
 - ❖ After range is selected now set the desired time as mentioned. Step No 8. Timer settings can be done only in timer mode.
 - ❖ To set the timer follow the instructions given below.
 - ❖ Press SET key- SET LED will start glowing.
 - ❖ Press TIMER key – Timer display shows last set value with right most digit flashing. To set the digit go to step c
 - ❖ Press ▲ key –Flashing digit value will show increment for every key press.
OR
Press ▼ key - Flashing digit value will show decrement for every key press.
 - ❖ Set the value for flashing digit.
 - ❖ Press DISP SEL next significant digit will flash. Now repeat step c to set the value. Repeat step d to set all digits. Press ENTER to accept the value .
 - ❖ Press ENTER key to complete the timer setting. Set LED goes off.
 - ❖ Start the test using START/STOP key. TIMER display shows the elapsed time starting from “00.000” if the timer range is min , sec (“-0.00” if the timer range is hrs . min)
 - ❖ In any mode , to START or to STOP the test press the START/STOP key. Warm distilled water to $37 \pm 2^{\circ}\text{C}$ and take in 1000ml beaker. The volume of the water should be such that the wire mesh of the moving basket at its highest point is at least 25mm below the surface of the liquid and at its lowest point is at least 25mm above the bottom of the beaker.

- ❖ Place the beaker in the disintegration test apparatus. Suspend the basket assembly in to the beaker by fixing it in to the moving shaft.
- ❖ Introduce one tablet in each of the six tubes of the basket of the assembly and place the disc in each.
- ❖ Press START/ STOP button and note the time.
- ❖ Run the instrument for required period and switch off. Lift the basket and observe for completion of disintegration.
- ❖ **Cleaning:**
- ❖ Empty the beaker and clean.
- ❖ Remove the discs and clean the disintegration test apparatus.

End of Document



5. SOP FOR DISSOLUTION APPARATUS

	Prepared by		
Document Number	Name	Signature	Date
CCP005	Dr. Azza Ali Hasan Assistant Professor, Department of Pharmaceutical Sciences, College of Clinical Pharmacy, KFU		
Revision Number	Approved by		
R0	Dr. Ibrahim Alhaider Dean, Department of Pharmaceutical Sciences, College of Clinical Pharmacy, KFU		

Document History

Document Section	Details of Amendments	Date	Modified by (Initials)
SOPs -	First Draft on SOP for the operation of Dissolution apparatus	/ /2011	Dr. Azza

1. OBJECTIVE

The following document describes the procedure on the operation of Dissolution apparatus.

2. SCOPE

Dissolution apparatus is used in the pharmaceutical industry to determine the rate at which pure active pharmaceutical ingredients dissolve.

3. RESPONSIBILITIES

- ❖ It is the responsibility of designated personnel in Research lab to train staff and students on this procedure and to ensure adherence to this procedure.
- ❖ It is the responsibility of designated personnel (staff or Student) to follow the instructions of this procedure.

4. REFERENCES

Instruction Manual (Operation Guide) Erweka company for Dissolution apparatus.

5. DEFINITIONS

Dissolution is defined as the process by which a known amount of drug substance goes into solution per unit of time under standardized conditions.

The bioavailability and bioequivalence data obtained as a result of dissolution testing can be used to guide the development of a new formulation and product development

6. PRECAUTIONS

No part of the assembly, including the environment in which the assembly is placed, contributes significant motion, agitation, or vibration beyond that due to the smoothly rotating stirring element.

7. PROCEDURE FOR OPERATING THE DISSOLUTION APPARATUS:

- ❖ **Stirring Element Height**—Set the distance between the bottom of the vessel's inner surface and the lower part of the stirring element. Use height gauges to check the distance between the bottom of the vessel and stirring element. Measure the distance for each vessel position. Some test assemblies allow the height of the stirring element to be set before beginning the test. All values must be within 23.0 and 27.0 mm.
- ❖ **Baskets**—Place one tablet in each dry basket. Attach the basket to its shaft. The test is considered to start when the basket is immersed in the medium at the prescribed height. Immediately start the stirring.
- ❖ **Paddles**—Allow the tablet to fall into the vessel in a standardized manner, e.g. along the vessel wall or at the center of the vessel along the paddle shaft. The test is considered to start when the tablet comes to rest at the bottom of the vessel. The most reproducible conditions will exist with the sample settled directly under the paddle shaft (e.g., on the vessel axis). Immediately start the stirring.
- ❖ **Timing**—Record the start time of the dissolution test using a calibrated timing device. The type of starting procedure must allow for sample collection and filtration of all positions within the current $\pm 2\%$ tolerance limit for time (± 36 seconds for a 30 minute run). The time needed to sample each vessel may be

accommodated with a staggered start allowing a minimal start-time interval between vessels and is recommended if possible.

- ❖ Observations—Carefully record any visual observations of the dissolution test, such as basket wobble, air bubble formation, or the condition or motion of the disintegrating tablet particles.
- ❖ Sampling—Withdrawal and filtration of the sample aliquot conclude the test interval. After 30 minutes of testing and with rotation continuing, withdraw a portion of the dissolution medium from each vessel, about 30 mL. Sample from a zone midway between the surface of the dissolution medium and the top of the basket or top of the paddle blade, not less than 1 cm from the vessel wall.
- ❖ Filter each sample immediately through a syringe filter (0.45- μm PVDF-type or equivalent), discarding the first 5 mL portion of filtrate. [Note: Equivalent filters will provide filtrate with analytical response within 1% of the unfiltered solution. Discard volume is a function of the filter and may not be identical to that recommended in this document.] Cool the filtered dissolution samples to ambient temperature prior to UV analysis (sample and standard solutions are at the same temperature). Do not centrifuge the sample. A separate unused filter, cannula, and clean syringe should be used for each vessel.
- ❖ Automated Sampling
- ❖ If used, automated sampling methods and filter probes should be validated against the manual sampling method. Variables include, carry over from system surfaces exposed to test solution, dwell time for on-line spectrophotometric analysis, and filter interference.

End of Document

6. SOP FOR FREEZE-DRYER (BENCH TOP)

	Prepared by		
Document Number	Name	Signature	Date
CCP006	Dr. Azza Ali Hasan Assistant Professor, Department of Pharmaceutical Sciences, College of Clinical Pharmacy, KFU		
Revision Number	Approved by		
R0	Dr. Ibrahim Alhaider Dean, Department of Pharmaceutical Sciences, College of Clinical Pharmacy, KFU		

Document History

Document Section	Details of Amendments	Date	Modified by (Initials)
SOPs -	First Draft on SOP for the operation of Millrock Bench-Top Freeze-Dryer	/ /2011	Dr. Azza

1. OBJECTIVE

The following document describes the procedure on the operation of Millrock Bench-Top Freeze-Dryer.

2. SCOPE

Freeze Drying, or lyophilization as it is referred to in the Pharmaceutical and Diagnostic industries, is a dehydration technique, which enables liquid or slurry products, which have previously been frozen to be dried under a vacuum. The applications of freeze drying are numerous, such as

- ❖ Preservation of temperature sensitive products, particularly those of biological origin, such as enzymes, blood plasma, vaccines, etc.
- ❖ To achieve a chemical balance, such as for biological reagents.
- ❖ To provide a practical solution for certain delivery problems, for example, the packaging of constituents that cannot be mixed in the liquid state, but which are solidified in successive stages and then freeze dried.
- ❖ To implement an important stage of a product (such as concentration).
- ❖ To improve storage life and improved marketing of the pharmaceutical product.

3. RESPONSIBILITIES

- ❖ It is the responsibility of designated personnel in Research lab to train staff and students on this procedure and to ensure adherence to this procedure.
- ❖ It is the responsibility of designated personnel (staff or Student) to follow the instructions of this procedure.

4. REFERENCES

Instruction Manual (Operation Guide) Copyright ©2009 Millrock Technology.for Millrock Bench-Top Freeze-Dryer.

5. DEFINITIONS

Biological materials typically must be dried to stabilize them for storage, preservation, or shipping. Many times, drying causes damage and some loss of cellular or protein activity.

Lyophilization, called freeze-drying, is a method of sample preservation that significantly reduces damage to biological samples.

6. PRECAUTIONS

- ❖ Wear Appropriate Eye Protection At All Times When Working With Or Anywhere Near A Lyophilizer.
- ❖ For Medical Emergencies, Fires, Or Explosions, Call emergency number Immediately And Report The Details Of The Incident.
- ❖ If solvents are part of the product being freeze dried, they may be flammable or hazardous. Proper precautions should be taken.
- ❖ Acids and bases may cause damage to the stainless steel and vacuum pump.
- ❖ If the gas ballast is left open for extended periods, the oil can be pumped out the exhaust, causing the pump to fail.
- ❖ Do not fill the chamber above the vacuum port as water will enter the vacuum tubing and drain into the vacuum pump.
- ❖ Do not chip the ice from the condenser or chamber If acid or base products are collected, immediately neutralize and dispose of properly

7. PROCEDURE FOR OPERATING THE Freeze dryer

7.1. Inspection of glassware & seals:

Use only glassware designed for the lyophilizer!!

The lyophilizer, when in good working order, should have a pressure of 5-50 millitorr (normal atmospheric pressure is 760 torr), as indicated on the LED screen. (If the pressure is outside of this range, contact one of the people listed above.) This means that all glassware attached and under vacuum on the lyophilizer represents a significant implosion hazard.

All glassware used on the lyophilizer must be free of any visible defect (cracks, chips, or scratches), no matter how seemingly minor. Any glassware that is defective in this way must not be used under any circumstances. If such glassware is found, it should be discarded. The seals themselves are somewhat more forgiving, in that a defective seal reduces the vacuum. However, defective seals should still be removed from service.

A greater risk is present in seals that connect two pieces of glass. All seals of this type place rubber between joined pieces of glass. If these seals are used improperly, the glass pieces come into contact and scratch each other during installation. These scratches compromise the integrity of the glass thus creating a potentially serious implosion hazard. Install any seals of this type carefully to avoid this; if you are uncertain of how to do this do not proceed until you have received further training from one of the contact people given above.

7.2. Most vacuum pumps are supplied with a gas ballast adjustment. It is recommended that the gas ballast be closed during the operation of the Freeze Dryer.

Push the RUN button 2X

- ❖ The first time you press the run button the displays a reminder to check the system.
- ❖ The second press activates the freeze drying run.
- ❖ The Condenser will get below -40°C (CTVAC) within 10min (CTtim).
- ❖ After 10 minutes of operation, the vacuum pump will start.
- ❖ Vacuum will go to 500mT(VACRDY) within 10min(VACTim):
- ❖ If NO - alarm will sound and "VACU > 500mT, after 10min" will flash on the lower part of the screen.
- ❖ If YES – then "READY FOR FREEZEDRYING" will flash at the top of the screen.

7.3. Adding product to the manifold for freeze-drying:

- ❖ Make sure that the product is frozen in the flask before attaching to the freeze dryer.
- ❖ When freezing product in flasks, the flask should be tilted on its side.
- ❖ If the flask is not tilted the expansion of freezing will break the flask.
- ❖ Attach the flask to the vacuum valve using a 3/4" to 1/2" adapter.
- ❖ Make sure that the adapter is greased.
- ❖ Slowly open the valve to apply vacuum to the flask.
- ❖ Wait for the "READY FOR FREEZE-DRYING" indication before adding additional product.

7.4. Removing product from the system:

To remove the product from the system, you must remove the vacuum in the flask/vial/container (without removing the vacuum in the freeze dryer). Simply turn the valve stem past closed to release the vacuum. The vacuum is released through a small opening in the valve stem.

7.5. Defrost:

When a sufficient amount of material accumulates on the condenser, the frozen material will obstruct the vapor flow. At this point, the system must be defrosted.

Remove any unfinished product and keep it frozen. The Opti-dry offers hot gas-defrost to speed the defrosting process.

- ❖ Add approximately 1 liter of warm water to the condensing chamber, making sure not to fill above the vacuum port at the rear of the chamber.
- ❖ Press the "DEFROST" button.

The compressors will direct hot gas to the condenser coil until it reaches +40°C then cycle off. If the presence of cold water is detected the controller will repeat the process until all ice is melted.

End of Document

7. SOP FOR FOURIER TRANSFORM INFRARED SPECTROSCOPY

	Prepared by		
Document Number	Name	Signature	Date
CCP007	Dr. Mahesh Attimarad Assistant Professor, Department of Pharmaceutical Sciences, College of Clinical Pharmacy, KFU		
Revision Number	Approved by		
R0	Dr. Ibrahim Alhaider Dean, Department of Pharmaceutical Sciences, College of Clinical Pharmacy, KFU		

Document History

Document Section	Details of Amendments	Date	Modified by (Initials)
SOPs -	First Draft on SOP for the operation of Shimadzu FTIR 8400S	/ /2011	Dr. Mahesh

1. Purpose:

The following document describes the procedure on the Operation of the Shimadzu FTIR.

2. Scope:

This instrument is used to determine the functional groups present in the organic compounds.

3. Responsibilities:

- ❖ It is the responsibility of designated personnel in Research lab to train staff and students on this procedure and to ensure adherence to this procedure.
- ❖ It is the responsibility of the students/technicians to follow the SOP as described and to inform the instructor about any deviations or problems that may occur while performing the procedure.

4. References:

- ❖ Shimadzu instruction manual IRPresetige-21 FTIR-8400S Operation guide.
- ❖ Shimadzu Instructional manual FTIR-8400S User's system Guide.

5. Definitions:

- ❖ FTIR: Fourier Transform Infrared
- ❖ KBr Pellet: Absorbance of IR by Solid samples are measured in KBr pellets, Which is prepared by pressing mixture of 1:100 solid sample: KBr.

6. Precautions:

Regularly Check the desiccant and change if more than 30% has converted in to pink color.

7. Procedure for operation of FTIR.

7.1. Preparation of KBr Pellet for solid samples

- ❖ Dry IR-grade KBr in a drying oven for at least 1 hour.
- ❖ Allow the KBr to cool in a desiccator. Weigh out 300 mg and place in a marble mortar and pestle and grind to fully powder it.
- ❖ Carefully weigh 3 mg of the finely ground solid sample and place in the marble mortar and pestle with the KBr.
- ❖ Grind for 60 seconds to thoroughly mix.
- ❖ Place the KBr-compound mixture into an evacuable die on a hydraulic laboratory press. Press *in vacuo* at 15,000 pounds of pressure for 6 minutes.
- ❖ Release the pressure, remove the die from the press, disassemble the die, and remove the KBr pellet. Place the KBr pellet in a pellet holder and put it into the sample beam of an IR.

7.2. Operation of Software

- ❖ Turn on the FTIR by pressing On/Off button which is in front of the Instrument.
- ❖ Click on the FTIR icon
 - A dialogue box will appear
 - Press OK
 - Double clicking the FTIR Box located in the bottom left corner
- ❖ Select Measuring Mode
 - Transmittance (%T) – used for qualitative IR analysis

- Absorbance (abs) – used for quantitative IR analysis. The absorbance is directly proportional to the sample concentration.
- Interferogram (IFG) – used for special purposes
- Power Spectrum – used for special purposes

- ❖ Select Resolution
 - The recommended resolution for liquids and solids is 4 or 8
 - The lower the resolution the longer the run time of the sample

- ❖ Select Range
 - The desired range is 4000 cm^{-1} to 500 cm^{-1}
 - A range between 400 cm^{-1} and 350 cm^{-1} will display undesired water peaks

- ❖ Select Number of Scans
 - The number of scans ranges between 1 and 4000
 - Use more scans if the sample has a low concentration, is a thin film, or if the FTIR accessory decreases light to the detector
 - 20 scans at a resolution of 4 with a mirror speed of 2.8 only takes 20 seconds
 - The more scans the better s/n ratio

- ❖ View Scans
 - Leave on Auto
 - Controls the real time display of the spectra when scanning

- ❖ Scan Drop Down Menu
 - Initialize – Initialized optical compartment
 - Sample Scan – Starts sample measurement
 - Back Scan – Starts background measurement

- ❖ File Name
 - Enter file name
 - Text Box – Description of sample

- ❖ Executing Background Scan
 - Empty the sample holder
 - Click Bkg Start Button
 - To stop the background scan click stop
 - During the background scan do not use the close button (X)



- ❖ Sample Set-Up/Executing Sample Scan
 - Prepare sample KBr pellet as per the above procedure 7.1.
 - Place the KBr pellet in a pellet holder and put it into the sample beam of an IR
 - Click sample start
 - The scan can be paused by pressing stop
 - The scan can be resumed by pressing continue
 - The number of scans is displayed in the bottom left corner

- ❖ Saving/Reading the Spectrum
 - To save the spectrum with a new file name click file then save as

7.3. Data Analysis

- The spectrum is displayed automatically
 - Enlarge an area by clicking and dragging a box around the area to be enlarged
 - Zoom In – Left mouse click
 - Zoom Out – Double right mouse click
 - Select the Graph drop down menu and click auto scale to return to the original spectrum
-
- ❖ Displaying Peaks
 - Open display box by:
 - Selecting the calculation drop down menu and clicking peak table
 - Press the peak table button
 - Under graphic section press the zoom button to display the peaks

 - ❖ Peak Detection Box
 - The default threshold for absorbance is 0.1
 - The default threshold for transmittance is 80%

 - ❖ Threshold
 - Absorbance will search for peaks above 0.1
 - Transmittance will search for peaks below 80%

 - ❖ Noise Level
 - Default absorbance is 0.01
 - Default transmittance is 2%

 - ❖ Recalculate – generates a new peak table

 - ❖ Range Set – specifies the range in which the peaks will be generated

 - ❖ Selecting a Single Peak
 - Place cursor over the peak of interest
 - Click on the peak



7.4. Shutting down the instrument

- ❖ Close the Hyper IR 1.51 Software
- ❖ Remove the KBr pellet holder
- ❖ Turn off the computer

End of Document



8. SOP FOR FLYING SPOT SCANNING DENSITOMETER

	Prepared by		
Document Number	Name	Signature	Date
CCP008	Dr. Mahesh Attimarad Assistant Professor, Department of Pharmaceutical Sciences, College of Clinical Pharmacy, KFU		
Revision Number	Approved by		
R0	Dr. Ibrahim Alhaider Dean, Department of Pharmaceutical Sciences, College of Clinical Pharmacy, KFU		

Document History

Document Section	Details of Amendments	Date	Modified by (Initials)
SOPs -	First Draft on SOP for the operation of Shimadzu Flying Spot Scanning Densitometer	/ /2011	Dr. Mahesh

1. Purpose:

- ❖ The following document describes the procedure on the Operation of the Shimadzu Flying Spot Scanning Densitometer.

2. Scope:

- ❖ This instrument is used for qualitative and quantitative analysis of DNA, Protein, Pharmaceuticals etc.

3. Responsibilities:

- ❖ It is the responsibility of designated personnel in Research lab to train staff and students on this procedure and to ensure adherence to this procedure.
- ❖ It is the responsibility of the students/technicians to follow the SOP as described and to inform the instructor about any deviations or problems that may occur while performing the procedure.

4. References:

- ❖ Shimadzu Flying Spot Scanning Densitometer (CS-9301PC) instruction manual.

5. Definitions:

- ❖ TLC : Tin layer Chromatography

6. Precautions:

N/A

7. Procedure for operation of Densitometer.

- ❖ **Turn on the scanner** “ON” by flipping the yellow switch on the side of the machine. Automatically initialization starts and takes about 10 seconds..
- ❖ Start CS-9301PC data processing software by double clicking the CS-9301PC icon on the desktop.
- ❖ When communication between the scanner and the PC is established set back up parameters in the scanner to display the current coordinates, wavelength and absorbance.
 - Click on the <lambda> pushbutton, dialog box will open. Reset the wavelength to required wavelength and click on OK.
 - Click on <X go to> will open dialog box. Reset the X-axis coordinate to 50 and click OK. Use the same procedure to move the Y-axis stage as well.
 - Specify measurement result output by clicking on <config> dropdown menu and selecting scan configuration.

7.1 Execute as single lane scan

- ❖ Click on <scanner> in the main menu and select parameters.
- ❖ Click on <change> from the submenu and click on control parameters. Make sure that **SINGLE** is selected for lane.
- ❖ Press **START** button.
- ❖ Channel selection dialog box opens, select CH1.
- ❖ When file save dialog box opens, save the file with file name(eight alphanumeric characters)

7.2. Execute auto lane scan

- ❖ Click on <scanner> in the main menu and select parameters.
- ❖ Click on <change> from the submenu and click on control parameters. Make sure that **AUTO** is selected for lane.
- ❖ Press **START** button.
- ❖ Channel selection dialog box opens, select CH1.
- ❖ When the autolane scan is ended, use a submenu on the dialog box to save the file with file name.

7.3. Display

- ❖ Select <File> from the drop down menu
- ❖ Press on <File selection> Select the required file and click on <LOAD>.
- ❖ Selection dialog box opens Click on the CH1 radio button and press OK.
- ❖ Click on <Present> in the main menu, select radar from the dropdown menu to optimize the display.
- ❖ Read the data using cursor by clicking the right mouse button.

7.4. Peak Analysis

- ❖ Click on <Peak> and select Find Peaks.
- ❖ Processing parameters dialog box open.
- ❖ Set the width, Slope and Drift and press OK.
- ❖ To perform peak analysis select edit peak param from peak drop down menu.
- ❖ Select CH1 and click OK.
- ❖ To get peak information select peak list from peak drop down menu.

End of Document



9. SOP FOR GAS CHROMATOGRAPHY MASS SPECTROMETER

	Prepared by		
Document Number	Name	Signature	Date
CCP009	Dr. Mahesh Attimarad Assistant Professor, Department of Pharmaceutical Sciences, College of Clinical Pharmacy, KFU		
Revision Number	Approved by		
R0	Dr. Ibrahim Alhaider Dean, Department of Pharmaceutical Sciences, College of Clinical Pharmacy, KFU		

Document History

Document Section	Details of Amendments	Date	Modified by (Initials)
SOPs -	First Draft on SOP for the operation of Shimadzu Spectrofluorophotometer	/ /2011	Dr. Mahesh

1. OBJECTIVE:

The following document describes the procedure on the operation, of Shimadzu GCMS-QP2010 Spectrometer.

2. SCOPE:

- ❖ GC/MS analysis, where the effluent to the GC instrument is the feed to the MS instrument, is in wide use for confirmation testing of substances. Drug testing, manufacturing quality control, and environmental testing are some typical uses.
- ❖ This instrument is useful for qualitative and quantitative analysis of volatile organic compounds.

3. RESPONSIBILITIES:

- ❖ It is the responsibility of designated personnel in Research lab to train staff and students on this procedure and to ensure adherence to this procedure.
- ❖ It is the responsibility of designated personnel (staff or Student) to follow the instructions of this procedure

4. REFERENCES:

- ❖ Shimadzu GCMS –QP2010 system user's Guide.
- ❖ Shimadzu GCMS Direct sample inlet device DI-2010 instruction manual.
- ❖ Shimadzu auto injector/auto sampler AOC-20 user manual.

5. DEFINITIONS

GCMS : Gas Chromatography Mass Spectrometer

6. PRECAUTIONS

- ❖ GC column temperature should be below 280 °C.
- ❖ Don't run the samples having more than 300° C boiling point.
- ❖ During direct injection method use very less sample to avoid saturation of ionization chamber.

7. OPERATING THE GCMS SPECTROPHOTOMETER

7.1. Turning on the Instrument

- ❖ Open the regulator of helium gas cylinder which is outside the research lab
- ❖ Then Open the helium gas pipe regulator which is located below the AAS instrument.
- ❖ Set the Pressure between 7- 9kg.
- ❖ Switch on the Auto sampler power controller(Behind the GCMS)
- ❖ Turn on the Mass Spectrometer using the switch located on the lower left back panel of the instrument.
- ❖ Turn on the GC system using the switch located on the lower right front panel of the instrument.



7.2. Operation of GCMS software(GCMS solution)

- ❖ Click the GCMS Real time Analysis icon.
- ❖ Log in window will open and press OK (no password) to start Lab solution software.
- ❖ After you login, the data acquisition software will automatically come up.
- ❖ Click the **vacuum control Icon** to open the vacuum control windows.
- ❖ Click the auto start function to start vacuum system.
- ❖ Wait for at least four hours to get good vacuum.
- ❖ Select the peak monitor window and check the MS back ground.
- ❖ After good vacuum is achieved go for Auto tuning. And click auto tuning icon on the assistant bar.
- ❖ Check the Auto tuning result. If all ok you are ready for analysis.

7.3. Creating the method.

- ❖ Already created by you. You can change or edit the Method file to suit your experiment. If you change the method, please save it as your method, by clicking on “File”, and “Save Method File As”.
- ❖ After the data acquisition software comes up, click on File, and Open Method, in order to choose and open a data acquisition method.
- ❖ From method drop down menu select system selection and tick DI for direct injection operation and GC for GCMS operation.
- ❖ To create new method There are 3 tabs for entering information in the method.
 - The first tab has parameters for the auto-injector(Sampler).
 - The second tab has parameters for the gas chromatograph.
 - The third tab has parameters for the mass spectrometer.

The screenshot displays the GCMS software interface with the following parameters and settings:

- Inj. Port:** SPL1, **Inj. Heat Port:** INJ1
- Column Oven Temp.:** 30.0 °C
- Injection Temp.:** 200.0 °C
- Injection Mode:** Splitless
- Sampling Time:** 0.50 min
- Carrier Gas:** He, **Prim. Press.:** 500-900
- Flow Control Mode:** Linear Velocity
- Pressure:** 45.6 kPa
- Total Flow:** 24.0 mL/min
- Column Flow:** 1.00 mL/min
- Linear Velocity:** 35.9 cm/sec
- Purge Flow:** 3.0 mL/min
- Split Ratio:** 20.0
- Program:** Column Oven Temperature

The temperature program graph shows a linear increase from 30.0 °C at 0.0 min to 275.0 °C at 1.00 min, followed by a hold at 275.0 °C for 1.00 min, and then a return to 0.0 °C for the remainder of the run.

	Rate	Final Temperature	Hold Time
0	-	30.0	3.00
1	25.00	275.0	1.00
2	0.00	0.0	0.00
3	0.00	0.0	0.00

Total Program Time: 13.80 min

Column: Name DB-5 ms, Thickness: 0.25 um, Length: 30.0 m, Diameter: 0.25 mm

Buttons: Detail of Injection Port..., Ready Check..., GC Program..., Prerun Program, Time Program

The screenshot displays the MS parameters and a data table for the GCMS-QP2010:

- Ion Source Temp.:** 200 °C
- Interface Temp.:** 250 °C
- Detector Voltage:** Relative to the Tuning Result
- Solvent Cut Time:** 3.5 min
- Micro Scan Width:** 0 u
- Threshold:** 1000
- GC Program Time:** 13.80 min

Group#1 - Event#1	Start Time (min)	End Time (min)	Acq. Mode	Event Time(sec)	Scan Speed	Start m/z	End m/z	Ch1 m/z	Ch2 m/z	Ch3 m/z	Ch4 m/z	Ch5 m/z	Ch6 m/z	Ch7 m/z	Ch8 m/z
1	4.00	13.80	Scan	0.50	666	40.00	350.00								
2	0.00	0.00	Scan	0.00	0	0.00	0.00								

- ❖ Fill out the required parameters as per your sample analysis and Save the method.

7.4. Data acquisition



- ❖ Be sure to remember to put your vial in the autosampler carousel. You need to use a 2 ml autosampler vial with a Teflon-lined cap, such as Fisher Scientific part # 03-391-15.
- ❖ The minimum volume of solution should be sufficient so that the solution level will be high enough for the syringe needle to enter it.
- ❖ When you put the sample in the carousel, please note the number of the well in which you place the vial.
- ❖ Make sure that the solvent rinse vials contain the solvent you are using.
- ❖ On the left hand side, click on the “Sample Login” icon to enter sample information.

- The tuning file should remain as the default.
 - Specifies where the vial is located in the autosampler.
 - Enter a data file name, and a location for the file.
- ❖ Click on the “Standby” icon to download your acquisition method parameters to the instrument. When the “Start” icon becomes active, you can click on it to start your run.

7.5. Data Analysis

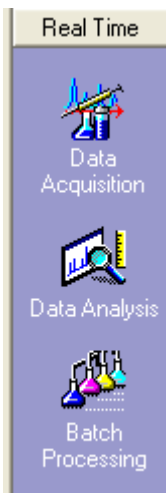

- ❖ When the data acquisition is complete, click on “Top” icon on the left hand side to move up one level. Then, click on the “Data Analysis” icon. Button, to launch the data Analysis program.
- ❖ The last data file acquired automatically comes up. If you wish to view a different file, just double-click the one in the list you want.
- ❖ Click and drag a box around peaks you want to zoom in on.
- ❖ Alternatively you can open the data file by clicking on GCMS Postrun analysis, Which is on the desktop.
- ❖ From the file dropdown menu open data file display the file you want.
- ❖ To display a mass spectrum of a chromatographic peak: right-click the mouse anywhere in the chromatogram to obtain a menu. Then left-click on “Average Spectrum” to get a cursor. Left-click and drag the cursor across the chromatographic peak, and its mass spectrum will be displayed.

7.6. How to acquire batch runs of large numbers of samples. (optional)

- ❖ To set up the batch table. Click on the Batch Processing Icon.
- ❖ After the batch table has been set up, put your samples into the auto-sampler carousel, and click on the Start icon to start the batch.

7.7. How to shut down the instrument when you are finished:

- ❖ Make sure that no data acquisition is in progress. Stop any data acquisition.
- ❖ Close the data acquisition program. Closing this program will log you off, so that you will not be billed for any more instrument time.
- ❖ Close any other software, such as the GCMS Postrun analysis program.
- ❖ Remove your samples from the autosampler carousel.

End of the Document

10. SOP FOR HIGH PERFORMANCE LIQUID CHROMATOGRAPHY

	Prepared by		
Document Number	Name	Signature	Date
CCP010	Dr. Mahesh Attimarad Assistant Professor, Department of Pharmaceutical Sciences, College of Clinical Pharmacy, KFU		
Revision Number	Approved by		
R0	Dr. Ibrahim Alhaider Dean, Department of Pharmaceutical Sciences, College of Clinical Pharmacy, KFU		

Document History

Document Section	Details of Amendments	Date	Modified by (Initials)
SOPs -	First Draft on SOP for the operation of Shimadzu Spectrophotometer	/ /2011	Dr. Mahesh

1. Purpose:

- ❖ The following document describes the procedure on the Operation of the Shimadzu HPLC.

2. Scope:

- ❖ This instrument is used to separate and quantify organic compounds in pharmaceutical formulations and biological fluids.

3. Responsibilities:

- ❖ It is the responsibility of designated personnel in Research lab to train staff and students on this procedure and to ensure adherence to this procedure.
- ❖ It is the responsibility of the students/technicians to follow the SOP as described and to inform the instructor about any deviations or problems that may occur while performing the procedure.

4. References:

- ❖ Shimadzu solvent delivery module LC-20AT prominence Shimadzu HPLC user's manual.

5. Definitions:

- ❖ HPLC : High performance Liquid Chromatography

6. Precautions:

- ❖ Always use guard column to avoid clogging of HPLC analytical column.
- ❖ Filter the mobile phase with 0.45 μ m filter paper.

7. Procedure:**❖ Degassing Solvents**

- ❖ Ensure there are enough degassed solvents before running a sample
- ❖ Get a 500 mL or 1000 mL Erlenmeyer filter flask
- ❖ Place your solvent and a stir bar into the flask and sit it on a hot plate
- ❖ Hook up a vacuum line and stopper the top of the flask
- ❖ Turn on the vacuum and the stir plate
- ❖ DO NOT HEAT
- ❖ The solvent is degassed when bubbles no longer appear
- ❖ Place parafilm over the filtering arm and parafilm the top of the flask after you put the tubing in.

7.1. Starting the Instrument**❖ Turning on the Instrument**

- Turn on the Column oven: CTO-10A
- Turn on the Liquid Chromatographs: LC-10AS
- Turn on the UV Detector: SPD-10AV

❖ Starting the Computer

- If the computer is off, long in to the system
- Open the program by Clicking on the HPLC Icon.
- Click OK (No password)
- Click Shimadzu LC Icon



7.2. Creating a Method

- ❖ Click the Method drop down menu
- ❖ Click LC Set-Up
- ❖ Make sure the instrument is isocratic mode, Click the Mode drop down menu ,Make sure Isocratic is checked.
- ❖ Time, Length of your method. Changes solvent system ratios when needed
- ❖ Adjust flow rate
- ❖ Percent Concentration Adjusts the graph limits.
- ❖ Click parameters Adjust flow rate and Adjust pressure.
- ❖ Click OK.
- ❖ Click the File drop down menu Click Exit

7.3. Saving the Method

- ❖ Click the file drop down menu
- ❖ Click save as
- ❖ Enter desired name of the method
- ❖ Click Save

7.4. Acquisition Set-Up

- ❖ Click the set-up icon
- ❖ Select Sample Frequency
- ❖ Ensure your frequency is 1 unit greater than your sample requires
- ❖ Enter Run Time
- ❖ Default is 5 minutes
- ❖ Save the method again

7.5. Running the sample.

- ❖ Select the run single icon (Has a blue arrow pointing to the right)
- ❖ Enter sample identification name
- ❖ Select the desired method (Select from browse button)
- ❖ Select the file destination (Select from browse button)
- ❖ Click start

7.6. Injecting the sample

- ❖ A blank should be run first
- ❖ Make sure the knob is turned to load
- ❖ Insert sample using a blunt tip syringe

7.7. Quickly turn the knob up to inject the sample



7.8. Select analyze icon. This will display retention times and peak areas

7.9. Shutting down the instrument.

- ❖ Wash the column with 50% water and 50% methanol or Acetonitrile for 10 min.
- ❖ To Stop the pump change the flow rate to 0 ml/min.
- ❖ Click on the pump icon.
- ❖ Turn off the Column oven
- ❖ Turn off the Liquid Chromatographs
- ❖ Turn off the UV Detector
- ❖ Exit from the HPLC software.
- ❖ Shutdown the computer.

End of Document



11. SOP FOR LIQUID CHROMATOGRAPHY MASS SPECTROMETER

	Prepared by		
Document Number	Name	Signature	Date
CCP011	Dr. Mahesh Attimarad Assistant Professor, Department of Pharmaceutical Sciences, College of Clinical Pharmacy, KFU		
Revision Number	Approved by		
R0	Dr. Ibrahim Alhaider Dean, Department of Pharmaceutical Sciences, College of Clinical Pharmacy, KFU		

Document History

Document Section	Details of Amendments	Date	Modified by (Initials)
SOPs -	First Draft on SOP for the operation of Shimadzu Spectrofluorophotometer	/ /2011	Dr. Mahesh

1. OBJECTIVE

The following document describes the procedure on the operation of Agilent LCMS.

2. SCOPE

Liquid chromatography coupled with mass spectrometry detection (LC/MS) is one of the most powerful analytical tools for organic compound analysis. The key advantages of using LC/MS methods over HPLC methods include:

- ❖ Selectivity. Co-eluting peaks can be isolated by mass selectivity and are not constrained by chromatographic resolution.
- ❖ Peak assignment. A chemical fingerprint for the compound of interest is generated, ensuring correct peak assignment in the presence of complex matrices.

- ❖ Molecular weight information. Confirmation and identification of known and unknown compounds.
- ❖ Structural information. Controlled fragmentation enables structural elucidation.
- ❖ Rapid method development. Provides easy identification of eluted analytes without retention time validation.
- ❖ Sample matrix adaptability. Decreases sample preparation time.
- ❖ Quantitation Quantitative and qualitative data can be obtained easily with limited instrument optimization.

3. RESPONSIBILITIES

- ❖ It is the responsibility of designated personnel in Research lab to train staff and students on this procedure and to ensure adherence to this procedure.
- ❖ It is the responsibility of designated personnel (staff or Student) to follow the instructions of this procedure.

4. REFERENCES

- ❖ Agilent LC/MSD Quick start guide..
- ❖ Agilent Chem-station for LC 3D systems, Understanding your spectra module.
- ❖ Agilent 6100 series Single Quad LC/MS system. User's Manual..

5. DEFINITIONS

- ❖ MSD : Mass spectrometer detector.
- ❖ LC: Liquid chromatography.

6. PRECAUTIONS

- ❖ Nitrogen gas generator should read less than 1 in the operating meter.

7. PROCEDURE FOR OPERATING THE AGILENT LCMS

7.1. How to switch on the instrument LC/MS

- ❖ First switch on the nitrogen generator.
- ❖ Operation pressure should be between 80-100.
- ❖ Then turn on the mass spectrometer
- ❖ Then HPLC instrument from down to up i.e. DAD, pump, degasser.
- ❖ Open the chem. Station by clicking on the online chem. Station icon.



7.2. How to Run the LC/MS

- ❖ Before running the LC/MS, you should first check the solvent reservoir to make sure that there is enough solvent available for the number of samples that you want to analyze.
- ❖ To create a new method select new method from the method drop down menu.
- ❖ Set the injection volume, by clicking on the injection icon.
- ❖ Set the flow rate of the mobile phase run time clicking on the column icon.
- ❖ Click on the DAD and set the wavelength/s required for detection of your analyte.
- ❖ Click on MSD and setup parameters (SCAN/SIM mode, m/z range etc)
- ❖ Than save the method.
- ❖ Alternatively to create new method, select Edit entire method from Method drop down menu and follow the steps.

7.3. For single run :

- ❖ Select sample info from the Run method dropdown menu
- ❖ Fill up the required information (vial no, sample name etc.)
- ❖ To run press Run Method.
- ❖ To view the DAD and MSD graph select signal 1 and signal 2 from the view and online signal dropdown menu.

7.4. For sequence run

- ❖ Select new sequence from the sequence drop down menu.
- ❖ Create new sequence table by filling the required information
- ❖ Than save the sequence table
- ❖ Than press run method

7.5. Calibration

- ❖ Open offline chem. Station software
- ❖ Select load signal from open sequence file drop down menu.
- ❖ Select MSD Or DAD signal and new calibration table and press OK.
- ❖ To add second point select load signal from
- ❖ Press add the level and feed the required information



- ❖ To calculate the unknown concentration load the unknown concentration signal and click report

7.6. Tuning of MSD (Once in a month)

- ❖ Select ATunes from View, MSD tune dropdown menu.
- ❖ Tune ---autotune with dual polarity.

7.7. Shut down

- ❖ Save the required information and click off instrument
- ❖ To switch off the MSD Select MSD vent form the View ---Diagnosis ---- Maintenance (Note: Switch off the MSD only if you are not using more than 15 days)
- ❖ Than close the chem. Station software
- ❖ Switch off the HPLC system up to down(degasser, pump, auto sampler, DAD)

End of Document



12. SOP FOR MICROSCOPE

	Prepared by		
Document Number	Name	Signature	Date
CCP012	Dr. Sahibzada Tasleem Rasool Assistant Professor, Department of Biomedical Sciences College of Clinical Pharmacy, KFU		
Revision Number	Approved by		
R0	Dr. Ibrahim Alhaider Dean, Department of Pharmaceutical Sciences, College of Clinical Pharmacy, KFU		

Document History

Document Section	Details of Amendments	Date	Modified by (Initials)
SOPs -	First Draft on SOP for the operation of BX41 System Microscope	/ /2011	Dr. Tasleem

1. OBJECTIVE

The following document describes the procedure on the operation of BX41 System Microscope

2. SCOPE

Microscopes are used to study living organisms and their fundamental processes.

3. RESPONSIBILITIES

- ❖ It is the responsibility of designated personnel in Research lab to train staff and students on this procedure and to ensure adherence to this procedure.
- ❖ It is the responsibility of designated personnel (staff or Student) to follow the instructions of this procedure.

4. REFERENCES

Olympus Instructions (Instruction manual) for BX41 System Microscope (AX7474)

5. DEFINITIONS

The resolving power of a microscope is the distance two objects must be apart and still be seen as separate and distinct

6. PRECAUTIONS

- ❖ Do not place the microscope on a flexible surface, as this could result in blocking the air vents and cause overheating or a fire.
- ❖ To prevent obstruction of the natural convection-based air cooling of the microscope, make sure to leave at least 10 cm of free space between walls or other objects, and the left, right and rear sides of the microscope and the lamp socket when installing the microscope.
- ❖ To avoid potential shock hazards and burns when replacing the light bulb, set the main switch at (OFF) then disconnect the power cord from the wall outlet in advance.
- ❖ Make sure the voltage selector switch ³ located on the rear side of the microscope frame is set to conform with the local supply voltage. (When shipped from the factory, the switch is set to 220-240 V.)
- ❖ Always use the power cord provided by Olympus. If no power cord is provided, please select the proper power cord by referring to the section “PROPER SELECTION OF THE POWER SUPPLY CORD” at the end of this instruction manual. If the proper power cord is not used, product safety and performance cannot be guaranteed.
- ❖ Always ensure that the grounding terminal of the microscope and that of the wall outlet are properly connected. If the equipment is not grounded, Olympus can no longer warrant the electrical safety and performance of the equipment.
- ❖ Never insert metallic objects into the air vents of the microscope frame as this could result in electrical shock, personal injury and equipment damage.
- ❖ The power cord may melt by the heat of lamp socket if the cord comes in contact with it. Distribute the power cord at an enough distance from the lamp socket.

7. INTRODUCTION

This microscope employs a UIS (Universal Infinity System) optical design, and should be used only with UIS eyepieces, objectives and condensers for the BX2 series. (Some of the modules designed for the BX series are also usable. For details, please consult Olympus or the catalogue.) Less than optimum performance may result if inappropriate accessories are used.

8. PROCEDURE FOR OPERATING THE BX41 SYSTEM MICROSCOPE

- ❖ Stabilize the BX41 System Microscope following all precautionary measures explained above.
- ❖ Set the main switch to “ I ” (ON) and adjust the brightness.
- ❖ Select the light path (trinocular tube).
- ❖ Place the specimen on the stage.
- ❖ Engage the 10X objective in the light path.
- ❖ Bring the specimen in focus..
- ❖ Adjust the interpupillary distance.
- ❖ Adjust the diopter.
- ❖ Adjust the light axis.
- ❖ Adjust the aperture iris and field iris diaphragms.
- ❖ Engage the desired objective in the light path and bring the specimen in focus.
- ❖ Insert the required filters.
- ❖ Adjust the brightness.
- ❖ Start observation.

9. MAINTENANCE AND STORAGE

- ❖ Clean all glass components by wiping gently with gauze. To remove fingerprints or oil smudges, wipe with gauze slightly moistened with a mixture of ether (70%) and alcohol (30%).
- ❖ The filter mount lens on the base is made of plastic. Do not rub it with a strong force to prevent damaging it.
- ❖ Do not attempt to use organic solvents to clean the microscope components other than the glass components. To clean them, use a lint-free, soft cloth slightly moistened with a diluted neutral detergent.
- ❖ Do not disassemble any part of the microscope as this could result in malfunction or reduced performance.

- ❖ When not using the microscope, keep it covered with a dust cover

10. **PRECAUTIONS:** If the microscope is used in a manner not specified by this manual, the safety of the user may be imperiled. In addition, the equipment may also be damaged. Always use the equipment as outlined in this instruction manual.

End of Document



13. SOP FOR NMR SPECTROMETER

	Prepared by		
Document Number	Name	Signature	Date
CCP013	Dr. Mahesh Attimarad Assistant Professor, Department of Pharmaceutical Sciences, College of Clinical Pharmacy, KFU		
Revision Number	Approved by		
R0	Dr. Ibrahim Alhaider Dean, Department of Pharmaceutical Sciences, College of Clinical Pharmacy, KFU		

Document History

Document Section	Details of Amendments	Date	Modified by (Initials)
SOPs -	First Draft on SOP for the operation of Bruker 400MHz NMR	14/3/2012	Dr. Mahesh

1. OBJECTIVE

The following document describes the procedure on the operation of Bruker 400MHz NMR.

2. SCOPE

This document applies to the procedures to run NMR experiments on the Bruker 400 MHz NMR.

3. RESPONSIBILITIES

- ❖ It is the responsibility of designated personnel in Research lab to train staff and students on this procedure and to ensure adherence to this procedure.
- ❖ It is the responsibility of designated personnel (staff or Student) to follow the instructions of this procedure.

4. REFERENCES

- ❖ Bruker NMR Instruction Manual (Operator's Manual).
- ❖ Programming Procedure for Bruker NMR.

5. DEFINITIONS

- ❖ NMR : Nuclear Magnetic Resonance .
- ❖ DEPT :Distortion less Enhancement by Polarization Transfer
- ❖ COSY: Correlation Spectroscopy
- ❖ NOESY: Nuclear Overhauser effect spectroscopy.

6. PRECAUTIONS

ALWAYS SET DEPTH with depth gauge!! Failure to set depth will break your sample and/or the instrument.

7. PROCEDURE FOR OPERATING THE Bruker 400MHz NMR Spectrometer.

- ❖ **Turning on the TOPSPIN software**
 - Switch on the PC
 - Wait until login screen appears
 - Switch on the Console
 - Wait at least 3 minutes
 - Login as "NMR User" and the PW is "topspin".
 - Start Topspin 3.0.
 - Ignore all error messages.
 - Type "**edhead**" in the command line (at the bottom of the screen)
 - Ignore the error message.
 - **Edhead** window opens Click on "exit".
 - **Channel Routing** window opens click on "close".
 - Type "**ii restart**" in the command line

The BRUKER 400 MHz NMR is ready to use.



7.2. Running the samples

- Select Start



- Click on "Create data set"
- Following window opens

 A screenshot of the 'New...' dialog box in Bruker TopSpin software. The dialog box has a blue title bar with the text 'New...' and a close button. Below the title bar, there is a blue instruction box that reads: 'Prepare for a new experiment by creating a new data set and initializing its NMR parameters according to the selected experiment type.' Below this, there is a form with several fields:

NAME	COURSE
EXPNO	1
PROCNO	1
DIR	/400
USER	decaturn
Solvent	CDC13
Experiment	Use current params.
TITLE	

- Enter name and experiment number
- Keep the PROCNO " 1" only
- Select the solvent that you are using from the drop down menu.
- Experiment : use current params.
- Title : Enter title and press OK
- New window opens

❖ To Read parameters

Select Proton for ^1H NMR, C13CPD for ^{13}C NMR,

DEPT : First perform C13CPD than DEPT 135p OR first DEPT 90 than DEPT135p.

2D NMR : COSYGPSW for (H, H COSY), Select HSQC GP for (C H COSY)

- Click "Read Pars"
- "rpar" window opens
- ☞ Select all and click OK

❖ Data Acquiring



Preparation of NMR sample: Prepare the sample in the required solvent and fill about 6 cm (4 cm to 8 cm, 6 cm is ideal). Insert the sample tube in to the spinner.

Keep the spinner into the sample depth gauge press the sample tube till it touches the white base. The bottom level should be set to 2 cm from the bottom (White base).

ALWAYS SET DEPTH with depth gauge!! Failure to set depth will break your sample and/or the instrument.

- Select Turn on sample lift air (ej) from Acquire main menu.
- Drop the sample tube on the red sample holder (Top of the instrument)
- Select Turn off sample lift air (ij)
- Wait till you hear tick sound.

❖ **Lock**

- Click on lock
- Solvents table will open
- Select the solvent and press OK

❖ **Tune :**

- Click Tune on yellow and select Tune/match probhead automatically.
- Wait till the message "atma finished"

❖ **Spin :**

- Spin is required for 1D for 2D 3D no need to spin
- Turn sample rotation on
- Wait till red arrow appear on sample

❖ **Shim:**

- Click on shim yellow button
- Wait till topshim complete appears.

❖ **Prosol:**

- click on prosol

❖ **Gain :**

- Click on gain and wait till finish.
- Check the scan time if required change. For 1H NMR set scan in multiples of 4 usually 16 scans.

❖ **GO:**



- To start scan click GO.
- Click on Acqu from the inner window to see the FID.

7.3. Data Process, Saving and Printing

- Click on Process main menu and select Proc spectrum



- **Click Adjust phase** . Using left button, scroll and to adjust phase. Click save+ return .
- **Click integrate**. Click to define beginning and end of integral; press left button and drag to define. Right click under integral to select. Adjust selected integral tails to be parallel with baseline by scrolling bias and then slope .
- **To calibrate**, click under integral and select calibrate. Click save+ return .
- **Click pick peaks**. Make sure define region is selected . With left button drag the box to include the top of all peaks to be picked. To add a peak, click and select peak with cursor and left click. Click save+ return
- **To save** : Select Publish from the main menu and save by selecting PDF.
- **To print** : Go to print on left hand,
- Options : select Print with layout-start plot editor
- Press OK.

7.4. To turn off the instrument.

- First eject sample by clicking on the acquire main menu and selecting Turn on sample lift air(ej).
- Remove the sample and inject again by selecting Turn off sample lift air (ij)
- Click on left corner icon (yellow).
- Press terminate TopSpin and press OK.

End of Document

14. SOP FOR NANO SPRAY DRYER

	Prepared by		
Document Number	Name	Signature	Date
CCP014	Dr. Sree Harsha Assistant Professor, Department of Pharmaceutical Sciences, College of Clinical Pharmacy, KFU		
Revision Number	Approved by		
R0	Dr. Arshia Shariff Asst. Professor, Department of Pharmaceutical Sciences, College of Clinical Pharmacy, KFU		

Document History

Document Section	Details of Amendments	Date	Modified by (Initials)
SOPs -	First Draft on SOP for the operation of Buchi Nano Spray Dryer B-90	/ /2011	Dr. Harsha

1. OBJECTIVE

Spray Drying is a unique method to convert a **solution, suspension** or **emulsion** into a solid powder in one single process step by using Nano Spray Dryer B-90.

2. SCOPE

- ❖ The latest application trends in pharmaceutical formulation and nanotechnology demonstrate the need for fine particles in small powder quantities and with very high yields.
- ❖ The Nano Spray Dryer B-90 is BUCHI's 4th generation lab scale spray dryer and is particularly designed to evaluate spray drying during the early stages of product development.
- ❖ The modular and flexible glass design makes it easy to spray dry a whole variety of applications and is ideal for feasibility studies in R&D laboratories where only milligrams of powder need to be dried.

- ❖ The output particle size of the Nano Spray Dryer B-90 is between 300 nm – 5 µm. Thus, the instrument is ideally suited to encapsulate particles and nano particles (<100 nm) from a solution or suspension.

3. RESPONSIBILITIES

- ❖ The Nano Spray Dryer B-90 is only to be used by laboratory and specialist personnel and other persons, who, because of their training or professional experience, are able to assess the dangers which can result while operating the equipment.
- ❖ Personnel without this training or persons who are in training require thorough instruction. These operating instructions are the basis.

4. REFERENCES

Operation Manual Nano Spray Dryer B-90, Version A

5. DEFINITIONS

- ❖ Dehumidifier : Air humidity changes occurring between different seasons and regions affect the spray drying process. By using the Dehumidifier B-296, the drying conditions are exactly defined and made reproducible by removing the water content with a cold trap at 5°C. The integrated hygrometer displays the air humidity.
- ❖ Aspirator : The drying air is sucked or blown through the device by the aspirator motor creating under pressure conditions. By regulating the aspirator speed, the amount of heated drying air can be increased or decreased.

6. PRECAUTIONS

- ❖ Please read these operating instructions carefully and act accordingly.
- ❖ The wearing of personal safety equipment such as safety glasses, protective clothing is necessary. The glass parts are to be visually checked regularly for possible damage, stars, cracks.

The following uses are expressly forbidden:

- ❖ Use of gases with unknown chemical composition.
- ❖ Spray drying of biohazardous materials such as viruses or bacteria.
- ❖ Spray drying of organic solvents in ‘open loop’ and without the Inert Loop B-295.

- ❖ Installation or use of the instrument in rooms, which require ex-protected instruments.
- ❖ Spray drying of substances which might explode or ignite due to the processing and the selected parameters of the Nano Spray Dryer B-90 or installed sub systems.
- ❖ Use of samples which might produce oxygen during the processing.

7. OPERATING INSTRUCTIONS

Watch this video link for reference before starting http://wn.com/spray_drying

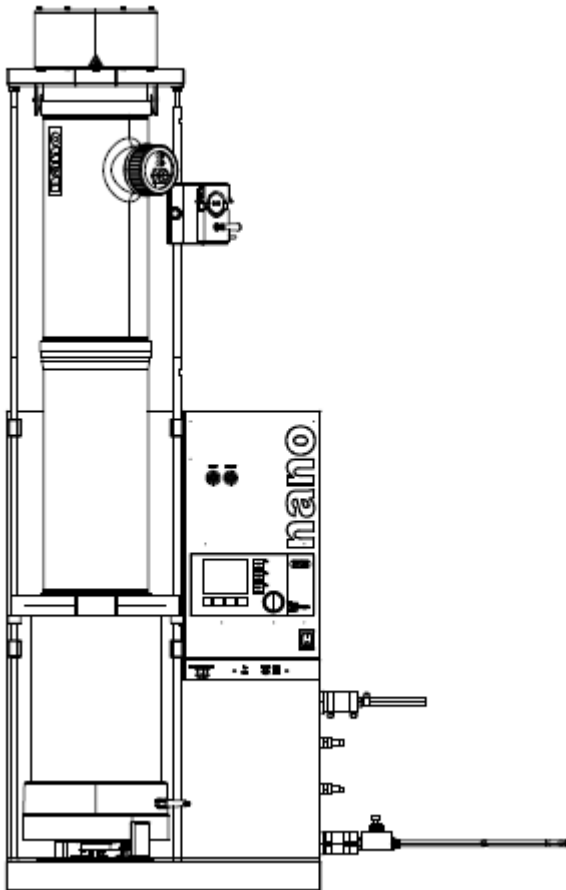

PROCEDURE FOR OPERATING THE NANO SPRAY DRYER B-90

Check that the voltage of the socket is the same as that given on the apparatus plate. The apparatus is supplied with an power cord which is directly plugged to the apparatus

Starting up the instrument

- ❖ Make sure the Nano Spray Dryer B-90 is properly connected to the mains supply.
- ❖ Carry out a final installation check (see section 5.9 REFER MANUAL) before every spray drying process.
- ❖ Switch on the Nano Spray Dryer B-90 at the main switch.
- ❖ Switch on all other electrical devices of the actual configuration at their main switch.

Main screen

After the internal system check at bootup finished successfully, the main screen view below appears at the Nano Spray Dryer B-90.

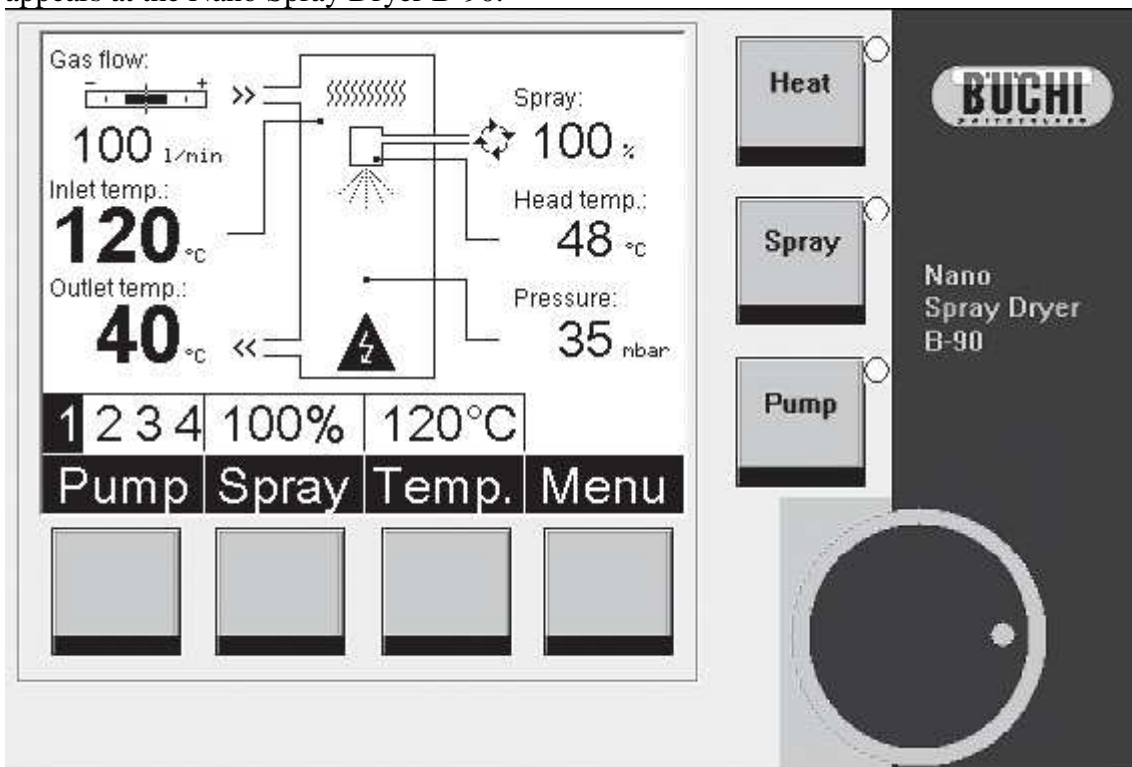

- | | |
|--|--|
| ① Display showing the current instrument status | ⑥ Heat button to switch the heater ON/OFF |
| ② Pump button to adjust the pump rate | ⑦ Spray button to switch spray function ON/OFF |
| ③ Spray button to change the relative spray rate | ⑧ Pump button to switch the pump ON/OFF |
| ④ Temp button to change the inlet temperature | ⑨ Selection knob to change process parameters and instrument configuration |
| ⑤ Menu button to enter the firmware menu structure | |

(Peristaltic) Pump selection

Four digits (1–4) are selectable:

- 1 — Clockwise pump rotation at standard speed
- 2 — Clockwise pump rotation at double speed
- 3 — Pump rotation direction alternates every 3 seconds
- 4 — Pump rotation direction alternates every 6 seconds

Spray selection

Select a spray head output between 0% and 100% spray rate. This directly effects the throughput of the spray head.

Temperature selection

Set the drying gas inlet temperature between 0 °C to 120 °C.

Note

The lowest possible drying gas inlet temperature in 'open loop' mode depends on the local room temperature.

Operating controls

Multifunctional buttons

The multifunctional buttons below the screen are programmable. Their actual use is displayed on the screen directly above the buttons.

Configuration ▶
Calibration ▶
Info ▶



1. Go back one step / Escape
2. Move cursor upwards
3. Move cursor downwards
4. Enter next menu level / OK (confirm selection)

Rotary knob

The rotary knob is used to select values out of lists within sub menus.

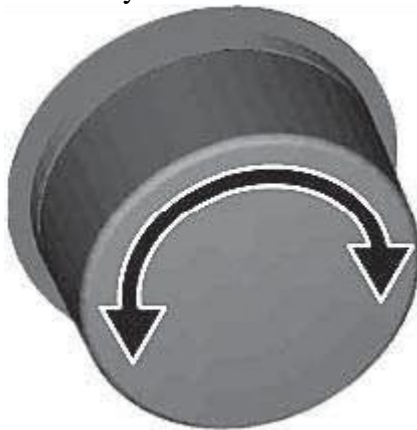

- Turning the knob clockwise moves the cursor downwards
- Turning the knob anticlockwise moves the cursor upwards

View parameters menu

- To enter the “Menu” press the corresponding multifunctional button below the screen. Inside the menu, use the multifunctional buttons for navigation.
- The “View parameters” menu and its sub menus provide information about the actual system status.
- It is accessible at any time and can supply the user with useful information about ongoing processes.



- No changes can be made here.

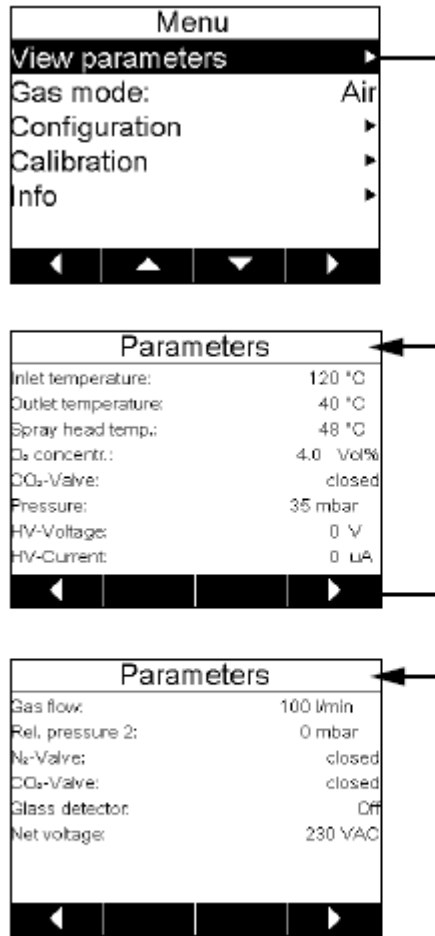

Note

In 'closed loop' mode the N₂ and O₂ valve open and close depending on the O₂ content in the gas loop to maintain the selected O₂ concentration (< 4% or <1%).

Configuration menu

To enter the "Menu" press the corresponding multifunctional button below the screen. Inside the menu, use the multifunctional buttons for navigation to "Configuration" and confirm the selection.



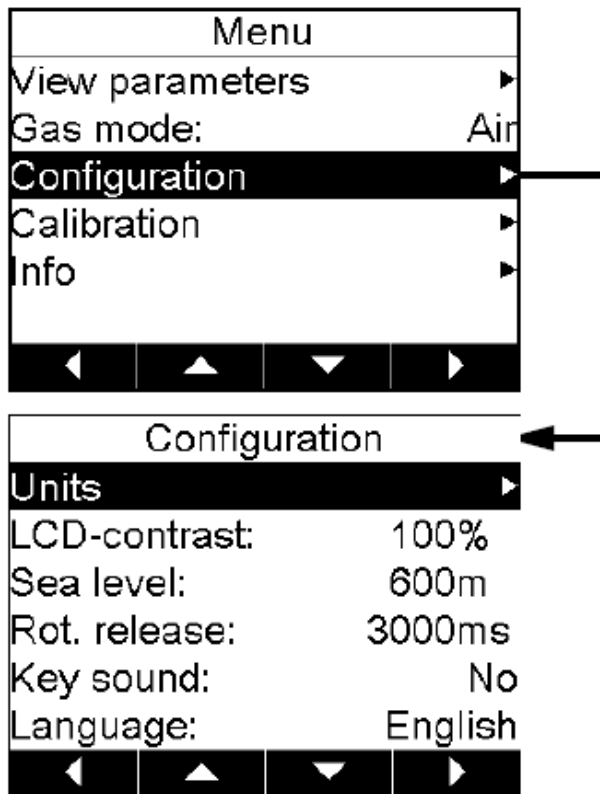

Items in menu "Configuration":	Description/ available parameters:
Units	<ul style="list-style-type: none"> • Temperature in °C, K or °F • Volume flow in l/min, m³/h, ft³/h • Pressure in mbar, Torr, hPa
LCD-Contrast	Select a screen contrast between 0 and 100%.
Sea level	Select the sea level in meters over sea level.
Rot. release	Defines the time interval in which the rotary knob is active after pressing the selection buttons for "Pump", "Spray" and "Temp.". The default time is 3 seconds. This is a feature to avoid unintended inputs.
Key sound	If "YES" is selected a sound is audible when pressing a function key. To suppress the acoustic confirmation select "NO".
Language	Choose the language of the user interface between Chinese, English, French, German, Italian, Japanese or Spanish.

Firmware calibration menu

- To enter the "Menu" press the corresponding multifunctional button below the screen. Inside the menu, use the multifunctional buttons for navigation to "Calibration". Stop the gas flow and confirm by pressing the "OK" button to recalibrate the internal flow sensor of the Nano Spray Dryer B-90.

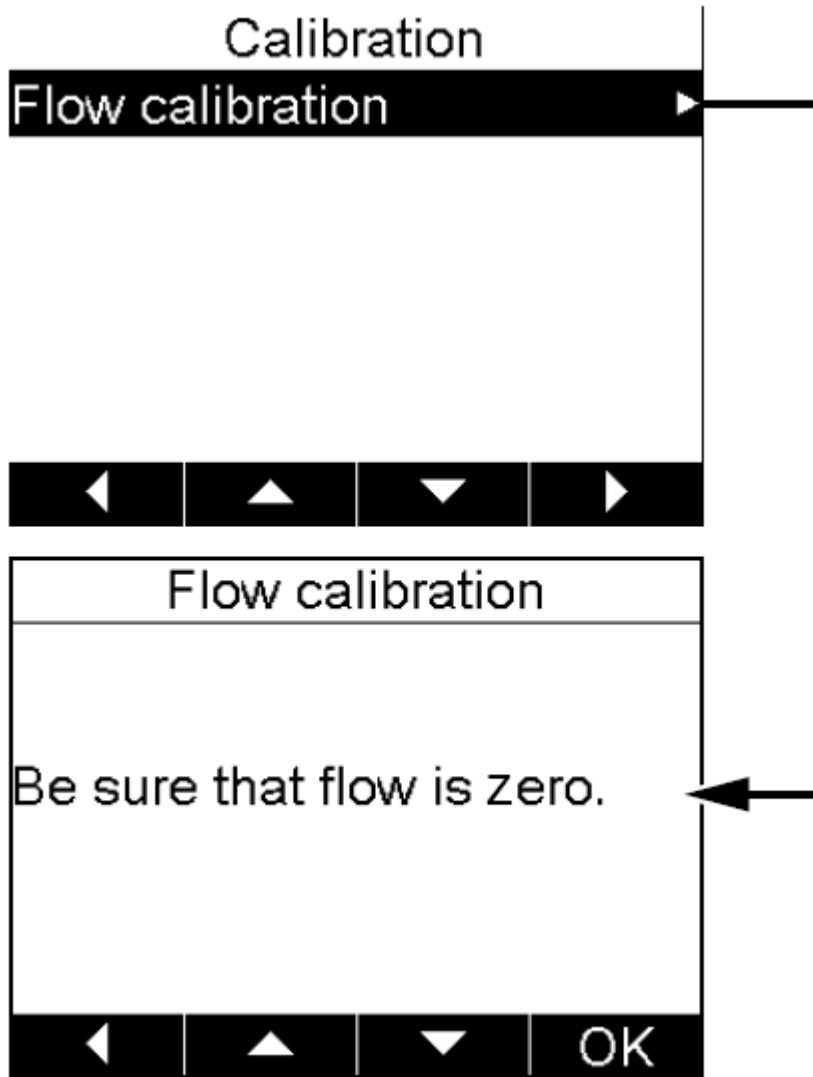
**Note**

The calibration should be performed periodically to ensure best spray drying results.

Starting a spray drying process

	<p>! Danger</p>
	<p>Death or serious poisoning by inhalation or incorporation of dried particles during spray process.</p> <ul style="list-style-type: none"> • Wear safety goggles • Wear safety gloves • Wear a suitable protective mask • Wear a laboratory coat • Check for proper sealing before use • Do not inhale dried particles • Stop drying gas flow before opening the drying circuit

Starting a spray drying process

- ❖ Switch on the instrument. After the automatic self check, the operating mode is activated.
- ❖ Switch on all other devices if installed in the current configuration.
- ❖ Set the drying gas rate to a reasonable flow of about 70 – 150 litre /min with the external gas regulator (when using compressed gas) or adjust the frequency controller when using the Aspirator (set a rotational frequency between 30 – 40 Hz).
- ❖ Read the relative inside pressure (typical pressure range 30 mbar to 60 mbar).
- ❖ Select the desired inlet temperature (typical setting between 80°C to 120°C).
- ❖ Switch on the heater by pressing the “Heat” button and wait until the system has reached stationary temperature conditions (typically after 5 to 10 min.).
- ❖ Switch on the peristaltic pump by pressing the “Pump” button.
- ❖ Select the relative spray rate (typically 100% to achieve maximum throughput).
- ❖ Press the “Spray” button to start the spray process.

The spray process starts and the electrical field in the particle collector is turned on.

Optimizing parameters

The relevant parameters for the spray drying process depend on each other.

- List of spray drying parameters
- drying gas flow rate
- relative inside pressure
- inlet temperature
- feed rate



The properties of the spray dried solution determines the maximum process temperature. The maximum thermal load of the solid particles is caused by the spray head temperature or by the maximum inlet drying gas temperature. To reduce the thermal load on the feed, the sample vessel may be cooled.

The achievable droplet sizes depend on the installed spray cap. Mean values for water applications are shown in the following table.

Table 6-1: Spray nuts

Spray cap (hole size)	Mean water droplet size ($D_{4,3}$)	Approx. water throughput	Span ($\frac{D_{90} - D_{10}}{D_{50}}$)
4.0 μm	8 μm	20 ml/h	< 1.4
5.5 μm	15 μm	60 ml/h	< 1.6
7.0 μm	21 μm	150 ml/h	< 1.6

End of spray drying process

 	Caution Risk of minor or moderate burning when handling hot parts.
	<ul style="list-style-type: none"> • Do not touch hot parts • Let the system cool down for some minutes after use







Finish a spray drying process

- Switch off the heater by pressing the “Heat” button and let the system cool down. Depending on the environmental temperature, this may take several minutes.
- Switch off the spray head by pressing the “Spray” button.
- Stop the gas flow at an inlet temperature below 70 °C.
- Read the internal pressure of the Nano Spray Dryer B-90. No overpressure should be present.
- Take out the pump inlet tube of the sample solution. The pump will now transport air, displacing product deposits in the tubing and spray head. Turn OFF the peristaltic

pump afterwards and lower the pump bed to release the mechanical load of the pulleys at the tube.

- See section 6.8 (USER MANUAL) before open the glass assembly in safe environment prior to any particle recovery!

Collecting the particles from the collector cylinder

      	<p>! Danger</p> <p>Death or serious poisoning by inhalation or incorporation of dried particles at recovery.</p> <ul style="list-style-type: none"> • Wear safety goggles • Wear safety gloves • Wear a suitable protective mask • Wear a laboratory coat • Do not inhale dried particles • Stop drying gas flow before opening the drying circuit • Only recover particles in sufficiently ventilated flue or glove-box • Do not disperse the dried particles • Do not clean dusty parts with compressed air
--	---

General information about particle recovery

- ❖ To recover the particles from the wall of the collecting electrode a particle scraper and collecting paper can be used. It allows recovering the particles manually and deposits the particles on a sheet of weighing paper.
- ❖ The electrostatic particle collector has very high separation efficiency. Nevertheless some particles may be deposited on the glass cylinder wall and the inner star electrode. These particles can be recovered carefully with a spatula or a brush.

Recommended set of tools for particle recovery

- ❖ Buchi particle scraper (order no. 11055338)
- ❖ Buchi weighing paper in A4 format (order no. 11055339)

Particle recovery procedure

- ❖ Place a blank sheet of weighing paper on a free area inside a fume hood.
- ❖ Remove the collector cylinder from the bottom basement of the particle collector.
- ❖ Place the collector cylinder on the sheet of paper.

- ❖ Use a particle scraper to collect particles from the cylinder.
- ❖ Lift the cylinder from the weighing paper and put it aside.
- ❖ Fill the powder from the sheet of paper into a storage vessel. Depending on the substance, a particle recovery rate of up to 90% can be achieved.

Note

Act carefully (e.g. avoid shaking movements) in order to prevent loss of particles. Clean all contaminated parts thoroughly to avoid hazardous situations and cross contamination. For information about cleaning, see section 7.6.(USER MANUAL)

Using the Nano Spray Dryer Records software on a PC

- ❖ The PC-software enables online data monitoring and storage of experimental runs in a virtual library.

Functionality

- ❖ Documentation of process data of experimental runs
- ❖ Export of process parameters for further data analysis

Connecting the instrument to the PC

Connect the Nano Spray Dryer B-90 to the PC by means of the USB cable. Insert the CD into the PC and follow the descriptions on the CD for system requirements and software installation.

End of Document



15. SOP FOR SERUM PROTEIN ELECTROPHORESIS

	Prepared by		
Document Number	Name	Signature	Date
CCP015	Dr. Sahibzada Tasleem Rasool Assistant Professor, Department of Biomedical Sciences College of Clinical Pharmacy, KFU		
Revision Number	Approved by		
R0	Dr. Ibrahim Alhaider Dean, Department of Pharmaceutical Sciences, College of Clinical Pharmacy, KFU		

Document History

Document Section	Details of Amendments	Date	Modified by (Initials)
SOPs -	First Draft on SOP for the operation of Biotec-Fischer Serum Protein Electrophoresis	/ /2011	Dr. Tasleem

1. OBJECTIVE

- ❖ The following document describes the procedure on the operation of Biotec-Fischer Serum Protein Electrophoresis

2. SCOPE

- ❖ Serum Protein Electrophoresis examines specific proteins in the blood called globulins.
- ❖ Serum protein electrophoresis is used to identify patients with multiple myeloma and other serum protein disorders.

3. RESPONSIBILITIES

- ❖ It is the responsibility of designated personnel in Research lab to train staff and students on this procedure and to ensure adherence to this procedure.
- ❖ It is the responsibility of designated personnel (staff or Student) to follow the instructions of this procedure.

4. REFERENCES

- ❖ MAESTRO 101 04/2005 Manual (Instruction manual) for Biotec-Fischer Serum Protein Electrophoresis
- ❖ Operating Manual for Serum Protein Electrophoresis MAESTRO 101 with Biotec-Fischer SPE Agarose gel kit code 370105.

5. DEFINITIONS

- ❖ Proteins: Serum proteins can be classified into Albumin, Alpha Globulins, Beta Globulins and Gamma Globulins
- ❖ Specimen: Freshly collected serum or a solution containing various proteins.

6. PRECAUTIONS

- ❖ Use the items (reagents and products) provided by the manufacturer
- ❖ Buffer contains Sodiumazide so it should not be mixed with acid and proper disposal, flushing with abundant water is required.
- ❖ Hemolysis may cause false elevation of alpha-2 and beta fraction of the proteins..
- ❖ Inaccurate results may be obtained due to specimen left uncovered.

7. INTRODUCTION

- ❖ MAESTRO 101 consists of two parts, a migration tank with an integrated power supply and a control unit for sequence programs with developing unit for migrated gels.
- ❖ Display elements and operation elements are located on developing unit.
 - Three(green, yellow and red) squares inform about the status of the unit where green light area means ready to work, yellow light area means active work in progress and red light area means fault in the status.
 - LCD display is a 4 line display that shows status of commands.
 - The operation elements include a knob used for data input and menu selection, while a red round button can interrupt the running process.
- ❖ **PROCEDURE FOR OPERATING THE MAESTRO 101**
 - Turn on the MAESTRO 101.
 - Prepare the migration tank by filling it with 30 mL of buffer solution.
 - Remove the reagent tray out of its position and fill each tank with 175 mL of corresponding solution (i.e. first with Fixative solution, second with Staining

solution, third and fourth with destaining solutions) and place them back in corresponding positions to the contents

- Select the predefined program sequence
- Take the gel and out of its package and place it on table with gel side up and dry it with gel blotter.
- Place the application template on marking at cathode side and press gently to remove the bubbles between template and gel.
- Fill each slid with 1 μL of diluted serum and wait for about three minutes to let the serum intrude completely.
- Place the small paper wick on application slides and place the gel in gel bridge with gel side up and place the gel bridge in the tank.
- Close the lid of the migration tank
- Select Learn parameter and then select migration tank on the controls
- Confirm the voltage (70 volts) and the migration time (25 minutes) and then launch migration.
- After migration, remove the gel from Gel Bridge and place insert it into gel frame.
- Place the gel frame into the moving arm and launch the developing procedure.
- Calculate the gel with Turboscan densitometer.

NOTE: DO NOT LEAVE WITHOUT PROPERLY SWITCHING OFF THE UNIT AND CLEANING THE GEL MOUNTS.

End of Document

16. SOP FOR SPECTROFLUOROPHOTOMETER

	Prepared by		
Document Number	Name	Signature	Date
CCP016	Dr. Mahesh Attimarad Assistant Professor, Department of Pharmaceutical Sciences, College of Clinical Pharmacy, KFU		
Revision Number	Approved by		
R0	Dr. Ibrahim Alhaider Dean, Department of Pharmaceutical Sciences, College of Clinical Pharmacy, KFU		

Document History

Document Section	Details of Amendments	Date	Modified by (Initials)
SOPs -	First Draft on SOP for the operation of Shimadzu Spectrofluorophotometer	/ /2011	Dr. Mahesh

1. OBJECTIVE

The following document describes the procedure on the operation of Shimadzu Spectrofluorophotometer.

2. SCOPE

Spectrofluorophotometer is used for qualitative and quantitative analysis of fluorescent organic and inorganic compounds.

3. RESPONSIBILITIES

- ❖ It is the responsibility of designated personnel in Research lab to train staff and students on this procedure and to ensure adherence to this procedure.
- ❖ It is the responsibility of designated personnel (staff or Student) to follow the instructions of this procedure.

4. REFERENCES

- ❖ Instruction Manual of Shimadzu Spectrofluorophotometer RF-5301PC series..
- ❖ Installation Procedure of control software for Shimadzu Spectrofluorophotometer.

5. DEFINITIONS

- ❖ Excitation wavelength:
- ❖ Emission wavelength

6. PRECAUTIONS

N/A

7. PROCEDURE FOR OPERATING THE AA SPECTROFLUOROPHOTOMETER

Starting the Instrument

- ❖ Turn on the computer,
- ❖ Turn on the instrument, The on/off switch is located on the lower right corner
- ❖ Starting the software, Double click the icon PC 150X

Soft ware Operation.

- ❖ To open the menu, Select acquire mode drop down menu
- ❖ Ensure spectrum is checked
- ❖ Select configure drop down menu
- ❖ Select spectrum parameter

- ❖ Select spectrum type
- ❖ When excitation is selected, the emission grating is in a fixed position
- ❖ When emission is selected, the excitation grating is in a fixed position

Enter desired parameters

- ❖ Excitation/Emission wavelength: 0, 220-900nm
- ❖ Excitation/Emission wavelength range: 220-900nm
- ❖ The minimum scanning range is 25
- ❖ Sensitivity can be set to high or low
- ❖ Recording range – limit of the graph
- ❖ allowable range is -100 to 1000
- ❖ Repeat Scan - allows automatic consecutive scanning from 2-100 scans
- ❖ Press OK.

Running an Experiment

- ❖ Loading a Sample
- ❖ Flip door down
- ❖ Insert a cuvette
- ❖ Close the door
- ❖ Click on the start button



- ❖ When the scan is completed the file name dialogue box appears
- ❖ Type in a file name
- ❖ Maximum of 8 characters
- ❖ A comment may be typed into the dialogue box

Select presentation drop down menu

- ❖ Press graph
- ❖ Press radar
- ❖ Both axes

Zoom In

- ❖ Click a drag a box around the area you wish to enlarge
- ❖ To return to full screen
- ❖ Right mouse click
- ❖ Select limits
- ❖ Press reset
- ❖ Press ok



Cross Hair Coordinates

- ❖ Right mouse click
- ❖ Select cross hair
- ❖ Select display
- ❖ To remove the cross hair coordinates press display again
- ❖ Select presentation drop down menu
- ❖ Select plot to display the plot layout window
- ❖ Under the graph column
- ❖ Click on the first box in row
- ❖ If it is already checked, uncheck the box then recheck the box
- ❖ The default for plot data is screen, this will print what appears on the screen
- ❖ Select Ok
- ❖ Select box under Params

Printing a Spectrum

- ❖ Click boxes 3 and 4 under quadrants
- ❖ The boxes are on the right side of the menu
- ❖ Select preview to display what will be printed
- ❖ Select Print

Shutting down the instrument

- ❖ Remove cuvette
- ❖ Close PC-1501 program
- ❖ Turn off instrument

End of Document



17. SOP FOR SPECTROPHOTOMETER

	Prepared by		
Document Number	Name	Signature	Date
CCP017	Dr. Mahesh Attimarad Assistant Professor, Department of Pharmaceutical Sciences, College of Clinical Pharmacy, KFU		
Revision Number	Approved by		
R0	Dr. Ibrahim Alhaider Dean, Department of Pharmaceutical Sciences, College of Clinical Pharmacy, KFU		

Document History

Document Section	Details of Amendments	Date	Modified by (Initials)
SOPs -	First Draft on SOP for the operation of Shimadzu Spectrophotometer	/ /2011	Dr. Mahesh

1. Purpose:

- ❖ The following document describes the procedure on the Operation of the Shimadzu UV-Visible Spectrophotometer.

2. Scope:

- ❖ This instrument is used to measure how much light of a given wavelength is absorbed by a liquid sample.

3. Responsibilities:

- ❖ It is the responsibility of designated personnel in Research lab to train staff and students on this procedure and to ensure adherence to this procedure.
- ❖ It is the responsibility of the students/technicians to follow the SOP as described and to inform the instructor about any deviations or problems that may occur while performing the procedure.

4. References:

- ❖ Shimadzu UV-Visible Spectrophotometer instruction manual PharmaSpec UV-1700 series Operation guide.
- ❖ Shimadzu UV-Visible Spectrophotometer instruction manual PharmaSpec UV-1700 series User's system Guide.
- ❖ Shimadzu Instruction Manual UV probe tutorial.

5. Definitions:

- ❖ Cuvette: A small, transparent quartz vessel. This is what a sample is put into for testing in the UV-Visible Spectrophotometer.

6. Precautions:

- ❖ N/A

7. Procedure for operation of Spectrophotometer.

- ❖ Open panel door and make sure cuvette holders are empty, then close the panel door.
- ❖ Flip open the display unit and Turn spectrophotometer “ON” by flipping the yellow switch on the side of the machine. The machine will automatically initialize.
- ❖ Connecting UV spectrophotometer to software
 - Turn on the system
 - Click the CPS1670 icon
 - On the instrument press F4
 - Press connect in the system, Instrument will automatically connect to computer software.

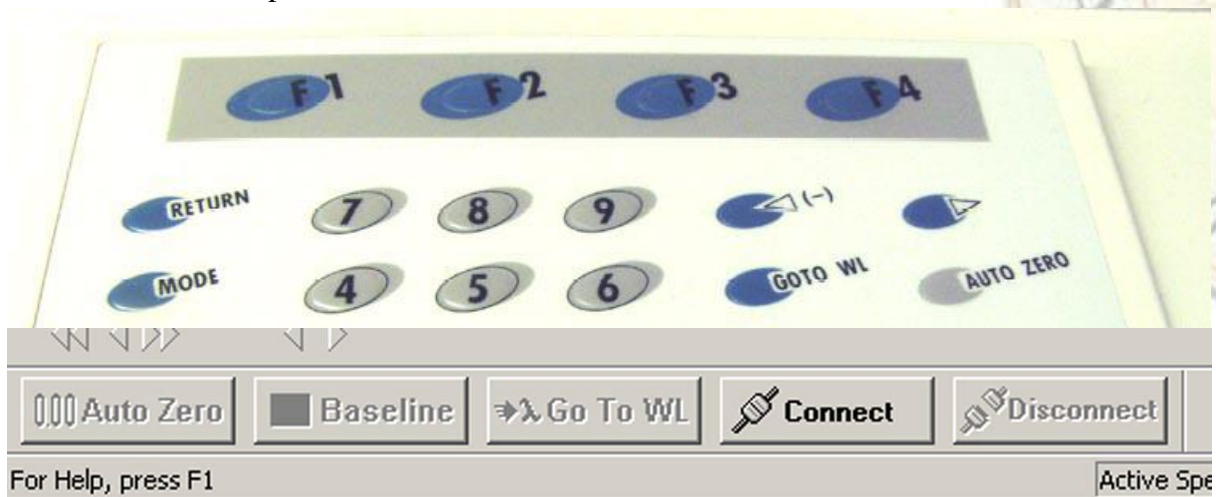

- Hold the cuvette from the top to prevent tampering with the measurements, and wipe the sides with a lab tissue.

- Open panel door and place the cuvettes with blank solution in the cuvette holders.
- **Make sure to use the appropriate orientation for the cuvettes you're using.**
- **Also make sure that the cuvettes used for the auto zeroing are the same cuvette**
- Press the **Baseline**



- When the Auto Zero is complete, open the panel door and remove the **front** cuvette.
- Do not replace cuvette in rear holder.
- Using the same cuvette style, fill an empty cuvette with about 2-ml of the sample.
- Clean the cuvette with a lab tissue.
- Place in front cuvette holder, using the appropriate orientation and close the panel door.
- Press **START** to take a reading.

❖ Saving the Spectrum

- Select spectrum from the drop down menu
- Press save as and give name and save.
- ❖ Open panel door and remove test sample from front cuvette holder.
- ❖ To test additional samples: Place cuvettes in front holder and press start for a reading.
- ❖ Press **RETURN** to bring you back to step Note: This will erase your old data.
- ❖ Remove cuvettes remaining in holders.
- ❖ Then click on the Disconnect button near the bottom of the screen.
- ❖ Exit from the UV-Probe software.

- ❖ Push the mode button on the UV-VIS instrument keypad.
- ❖ Flip power switch located on the side, to turn off the machine.

Important! Please go to the UV-VIS instrument keypad, and push the Mode button to return local control to the spectrometer. This allows the instrument to turn off the deuterium lamp, which will make the lamp last longer.

End of Document



18. SOP FOR SOXTEC EXTRACTION UNIT

	Prepared by		
Document Number	Name	Signature	Date
CCP018	Dr. Sree Harsha Assistant Professor, Department of Pharmaceutical Sciences, College of Clinical Pharmacy, KFU		
Revision Number	Approved by		
R0	Dr. Arshia Shariff Asst. Professor, Department of Pharmaceutical Sciences, College of Clinical Pharmacy, KFU		

Document History

Document Section	Details of Amendments	Date	Modified by (Initials)
SOPs -	First Draft on SOP for the operation of Soxtec 2045	/ /2011	Dr. Harsha

1. OBJECTIVE

To determine the concentration of the solute in the raw material by using Soxtec 2045.

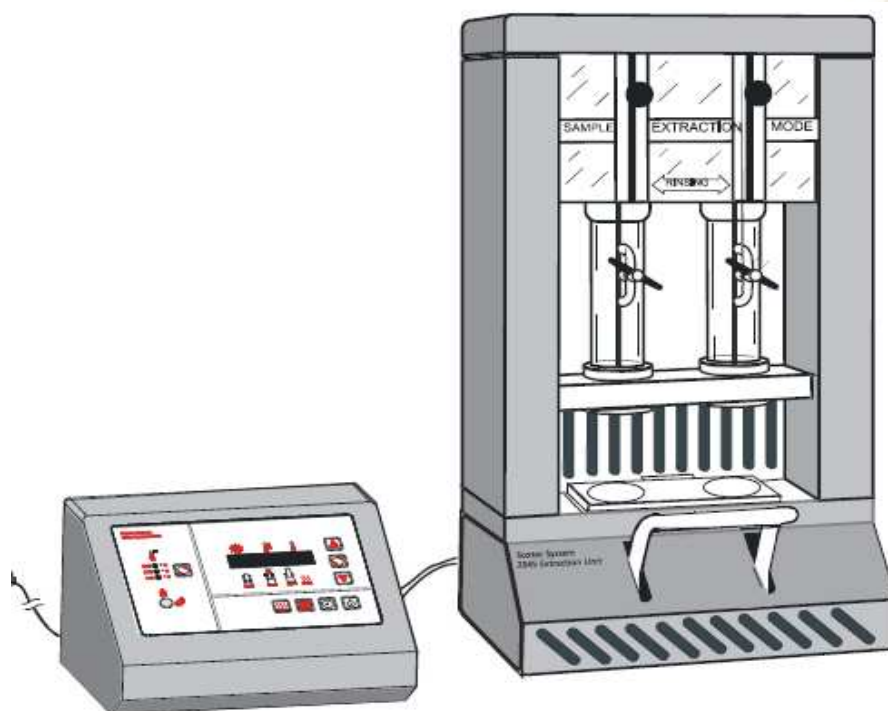

2. SCOPE

Extraction is used to isolate soluble matter such as crude fat, additives, pesticides and critical minor constituents from complex materials. The patented design of the Soxtec™ System 2045 makes it possible to perform extractions using a wide range of solvents, in a quicker, safer and more economical way compared to Soxhlet extractions. Thus, the technique normally reduces extraction times to less than 20% of Soxhlet times and recovers 60-70% of the solvent.

3. RESPONSIBILITIES

- ❖ It is the responsibility of designated personnel in Research lab to train staff and students on this procedure and to ensure adherence to this procedure.
- ❖ It is the responsibility of designated personnel (staff or Student) to follow the instructions of this procedure.

4. REFERENCES

A Soxtec™ System 2045 Extraction Unit User Manual 1001 1992 / Rev. 1.3

5. DEFINITIONS

- ❖ Thimble: Pure Cellulose
- ❖ Extraction Cup Holder: For inserting and removing of extraction cups the cup holder is used.
- ❖ Thimble Adapter: For attaching the thimbles in the Extraction Unit.
- ❖ Thimble Stand: The thimbles are placed in the thimble stand during drying.

6. PRECAUTIONS

- ❖ Please read these operating instructions carefully and act accordingly.
- ❖ Due to the explosion risk when handling organic solvents the operator should avoid exposure of solvents to open fire, static electricity etc.
- ❖ Laboratory coats and clothing made of certain synthetic fibres are prone to generate static electricity and should be avoided.
- ❖ The over-temperature setting should always be checked for each solvent used.
- ❖ Always use a damp cloth when wiping off surfaces on the extraction unit.

7. OPERATING INSTRUCTIONS

These captions are translated.

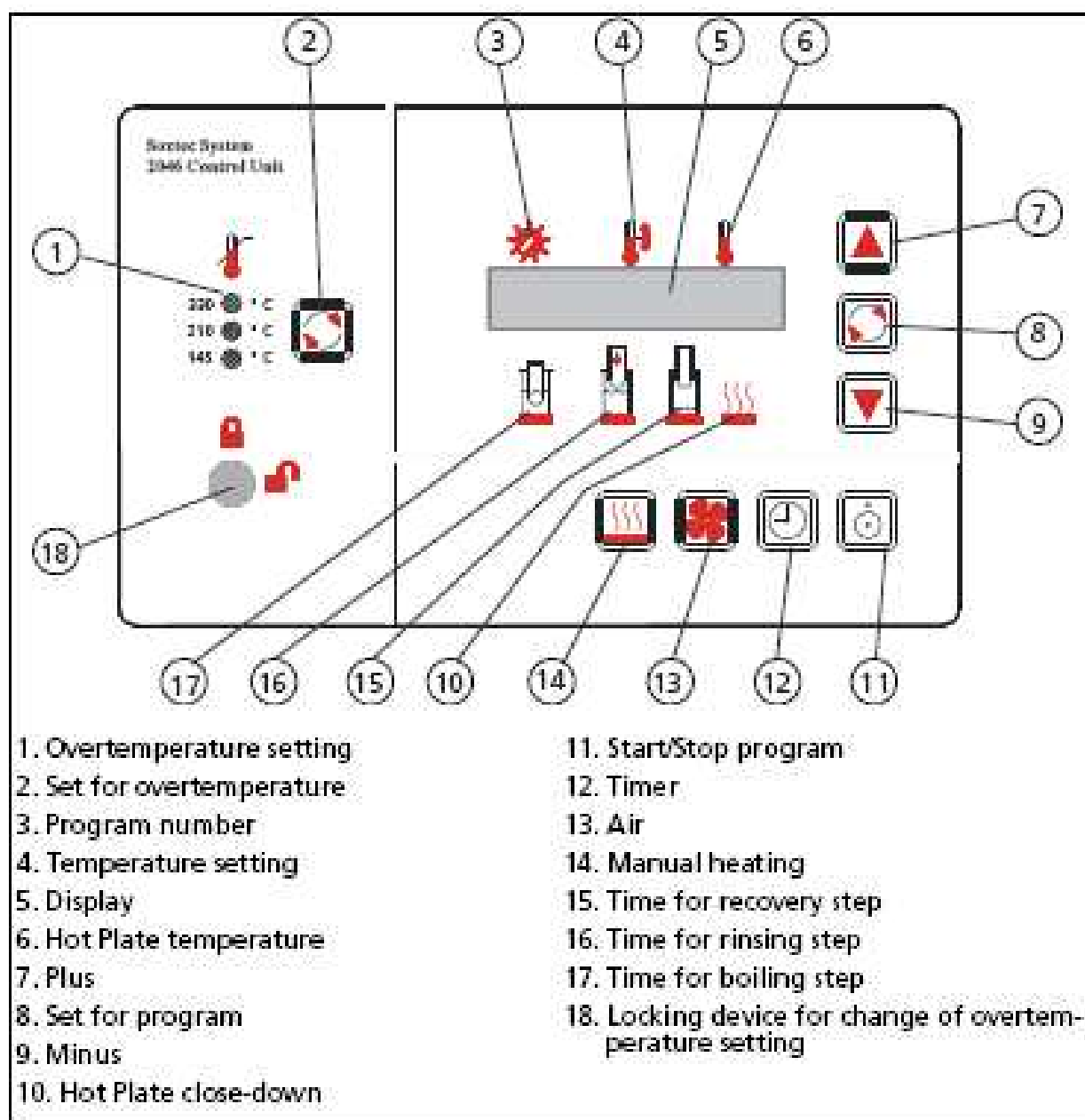



Fig. 5:1 The display on the Control Unit 2045(USER MANUAL)

8. PROCEDURE FOR OPERATING THE SOXTEC 2045







Control Unit Settings

Press the "POWER" key on the Control Unit (switch should light up), and the display will show the version number of the internal software before going to standby, e.g. showing the previously run program. Select a program #1 to #9 for analysis by pressing  or . Check that the over temperature setting is correct for the solvent used in the Application Sub Note.

Note: If the over temperature setting is not correct, or if there is no recommendation in the table, check with the laboratory supervisor that the correct setting is used.

If the application is being run for the first time and it is necessary to set up a new program, see next section.

Setting Up a New Program

Use the relevant Application Sub Note and Table 3, page 16, to set the correct temperatures and extraction times for the method. First select a program, with the   keys. Then use the  key and the   keys to set temperature and times for the different extraction steps. When finished, wait for the display to stop blinking or press the  key until you have passed the last extraction step. The recovery time should be set according to experience of the time needed for recovery of the solvent to the collection vessel. A typical value is between 5 and 10 minutes depending on solvent used and temperature. The fourth time can be used to keep the hot plate warm for up to 59 minutes if more analyses are to be performed later.

Cooling Water

Cooling water must be supplied to the system before the analysis starts. Adjust the flow rate to 1-2 l/min (20°C).

Pre-heating

The hot plate can be pre-heated prior to the analysis by pressing the  key. The hot plate will warm up to the set temperature for the program shown in the display.

Preparation of the Sample

To get correct results the pre-preparation of the sample is very important. For further information see Application Note 301.(USER MANUAL) Some types of samples e.g. meat, should be mixed with sand or celite. Follow the same procedure as for traditional Soxhlet.

Starting Up

- Press the "MAINS" button (switch-lamp should light up).
- Open the cold water tap for the reflux condensers. The flow should be adjusted to 1-2 l/min to prevent solvent evaporation from the condensers.

Extraction

- Attach the thimbles to the adapter (Fig. 5:2)

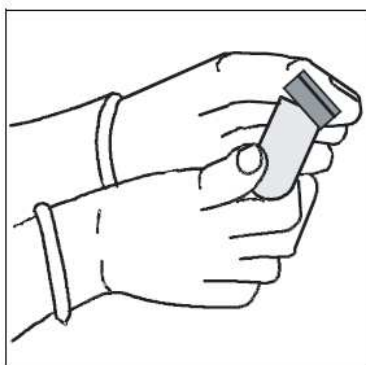

Fig. 5:2

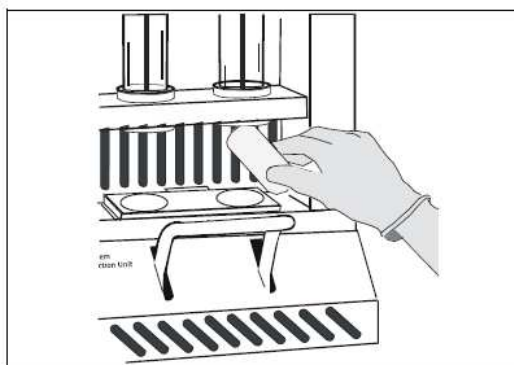

Fig. 5:3

- Weigh the sample and transfer quantitatively to the thimble.
- Put a defatted cotton wool plug on top of the sample.
- Move the knobs to the boiling position and insert the thimbles (Fig. 5:3). Lower the knobs to rinsing position; the thimbles will now hang just below the condenser valve.

- Press down heating plate handle and insert the extraction cups, tare with glass beads (5mm) and loaded with 50-70 ml of the solvent to be used. The cups are now clamped into the condensers (Fig. 5:4).

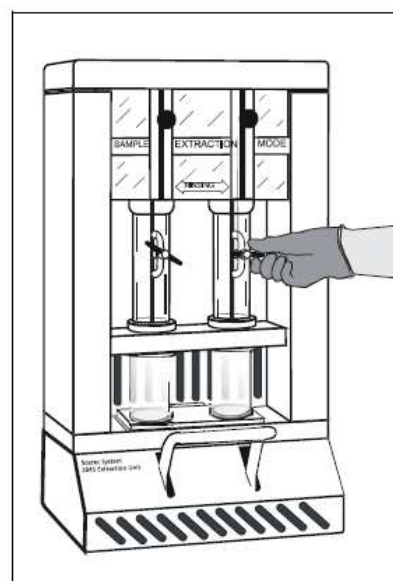





Fig. 5:4

- Start the program on the Control Unit by pressing the  key. The buzzer signal starts when the set temperature minus 5°C is reached. Press the timer key  and move the extraction mode knobs to the "boiling" position. Thimbles will now be immersed in the solvent.
- Boil with the thimbles immersed. (Time depending on sample and solvent type). Make sure that the condenser valves are open (Fig. 5:4).
- Move the extraction mode knobs to the "RINSING" position when the buzzer signal starts. The thimbles will now hang above the solvent surface. Press the timer key .

Solvent Recovery, Removal of Thimbles and Extraction Cups

- After rinsing, close the condenser valves by turning a quarter turn (Fig. 5:4).
- The air pump is automatically started when there is 3 min left of the analysis. The last traces of solvent will now be collected in the condenser. The Control Unit starts the buzzer signal when the countdown is finished. If you want to use the pump for a longer time (more than three minutes), you must start it manually. This may be necessary for high-boiling solvents like Toluene or Xylene. As soon as all cups are dry, lift the cups from the hot plate.
- Remove the thimbles.
- If another extraction is to be performed immediately, insert a new batch of thimbles and cups (5.2.7 Extraction on page 5:3 in USER MANUAL) and open the condenser valves.

Note: The recovered solvent volume can be adjusted by adding solvent at the top of the condenser.

Drying Step - Continue Heating

- It is possible to let the controller maintain the temperature of the hot plate for up to 59 minutes after the recovery step is finished.
- When setting up the program, set the fourth step on the controller to a desired value from 0 to 59 minutes.

Resetting the Over-temperature Protection

- Wait until the temperature of the plate is below the over temperature limit.
- Turn the power off.
- Turn the power on.
- Turn the over temperature key to unlocked. Turn the over-temperature key to locked.

Changing of Solvent

WARNING

Always be careful when changing solvent. You should for example check the ignition temperature of the new solvent used and make sure that the temperature of the hot plate does not exceed the ignition temperature.

Instructions:

- First empty the condensers from solvent.
- Run the system without samples and with a small amount (10-20 ml) of new solvent in the cups. Run a short program at the recommended temperature with the sample positioning rods in the rinse position for 10 minutes followed by recovery for 15 minutes.
- Collect the solvent from the cups.
- Discard the recovered solvent, as it will be contaminated by the solvent previously used.
- Repeat if you find it necessary.

Temperature Table

Note: The temperatures listed in the table below are given for guidance only; they may have to be adjusted for factors like room temperature, water temperature, heat transfer from hot plate to cup, etc.

A suitable temperature is when the drop rate is approx. 3-5 drops per second.

Table 3

SOLVENT	TEMP ALUMINIUM CUP (°C)	TEMP GLASS CUP (°C)	OT OVERTEMP (°C)
Acetone	150	180	330
Carbon tetrachloride	*	185	330
Chloroform	140	170	330
Chloroform-methanol (2:1)	140-150	170	330
Cyclohexane	170	205	210
Dichloromethane	120-130	160	330
Ethanol	250	285	330
Ethyl acetate	180	210	330
Heptane	170-180	185	210
Hexane	155	185	210
Methanol	250-260	285	330
Methyl ethyl ketone	160	220	330
Petroleum ether 30-60	135	160	210
Toluene	210-220	285	330
Trichloroethylene	185	240	330
Xylene	260	285	330

* = not recommended

The figures in Table 3 refer to aluminium and glass cups. OT (over-temperature) stands for the recommended setting on the over-temperature control pad on the Control Unit.

⚠️ WARNING

The over temperature setting should always be checked for each solvent used. Our recommendations are selected according to the ignition point. To be sure, you are advised to check the specific safety data sheet for the solvent to be used.

Closing Down

- Switch the 'MAIN' switch off.
- Turn off the cold water tap.
- Check that the condensers are free from solvent.

End of Document

19. SOP FOR SUPPOSITORY HARDNESS TESTER

	Prepared by		
Document Number	Name	Signature	Date
CCP019	Dr Arshia Shariff, Assistant Professor Dept of Pharmaceutics, College of Clinical Pharmacy, KFU		
Revision Number	Approved by		
R0	Dr Sreeharsha N Assistant Professor Dept of Pharmaceutics, College of Clinical Pharmacy, KFU		

Document History

Document Section	Details of Amendments	Date	Modified by (Initials)
SOPs -	First Draft on SOP for the operation of ERWEKA Suppository Hardness Tester SBT-2	06/ 12/2011	

1. OBJECTIVE

- ❖ The following document describes the procedure on the operation of ERWEKA Suppository Hardness Tester Type SBT-2

2. SCOPE

- ❖ The following procedure applies to designated personnel in Research laboratory

3. RESPONSIBILITIES

- ❖ It is the responsibility of designated personnel in Research lab to train staff and students on this procedure and to ensure adherence to this procedure.
- ❖ It is the responsibility of designated personnel (staff or Student) to follow the instructions of this procedure.

4. REFERENCES

- ❖ Instruction manual for operation of ERWEKA Suppository Hardness Tester Type SBT-2

5. DEFINITIONS

- ❖ Tempered suppository: The suppository whose temperature has been adjusted/ reset to measuring temperature.
- ❖ Thermostat: A device that monitors temperature and automatically maintains it at certain levels

6. PRECAUTIONS

- ❖ Before operating the thermostat, the water bath must be filled with water to the marked filling level. Otherwise the thermostat can be damaged.
- ❖ Do not touch the dry heating rods on the thermostat. You may burn yourself!!!
- ❖ Make sure that the water bath has reached the necessary operational temperature before you start a test.
- ❖ In case of any failure, the housing should only be opened by a qualified staff.
- ❖ Before opening the housing, pull the mains plug.

7. PROCEDURE FOR OPERATING THE ERWEKA SUPPOSITORY HARDNESS TESTER SBT-2

❖ SAMPLE PREPARATION

- The suppositories to be tested should be rested for at least 24hrs at the required measuring temperature before starting the test. Usually this temperature is at +25⁰C
- Measure the actual temperature in the measuring chamber using a thermometer.
- If required, adjust the temperature in the measuring chamber using the thermostat.

❖ PERFORMING TESTS

- Set the tester temperature to the required value by using the thermostat.
- Put the tempered suppository into the holding bracket that is made of red plastic with a tip pointing up.
- Carefully add the suspension rod assembly.

- Place the testing assembly into the testing chamber and start the time counting using a stop watch. The measurement starts. The initial load, determined by the weight of the complete rod assembly is 600g.
- After one full minute of testing, add an additional weight of 200g (one disc weight).
- After one minute, add the next weight.
- Continue the procedure until the suppository breaks under the corresponding total weight.
- Check the time of the test run on your stopwatch.

❖ EVALUATION OF TEST RESULTS

- If the suppository collapses under the initial weight of the suspension rod assembly i.e 600 grams, it has a strength value of less than 600 grams implying that the suppository is too soft and therefore not usable.
- When the suppository collapses within the range of added weights, the strength value is calculated as the total of the suspension rod assembly (600 grams) plus the value of the added weights (200 grams each).
- The value of the last weight added before the suppository collapses depends on the moment at which the collapse occurs.
- If the collapse occurs within 20 seconds from the moment the weight is applied, then the value of the weight is rated as zero.
- If the collapse occurs within 20 to 40 seconds from the appliance of the weight, the value of this weight is counted as 100 grams.
- If the collapse occurs after 40 seconds from the weight application, then the full value of 200 grams is included into the total applied load sum.

End of Document

20. SOP FOR TABLET ABRASION AND FRIABILITY TESTER

	Prepared by		
Document Number	Name	Signature	Date
CCP020	Dr. Sree Harsha Assistant Professor, Department of Pharmaceutical Sciences, College of Clinical Pharmacy, KFU		
Revision Number	Approved by		
R0	Dr. Arshia shariff Asst. Professor, Department of Pharmaceutical Sciences, College of Clinical Pharmacy, KFU		

Document History

Document Section	Details of Amendments	Date	Modified by (Initials)
SOPs -	First Draft on SOP for the operation of Tablet Abrasion -/ Friability Tester	/ /2011	Dr. Harsha

1. OBJECTIVE

The mechanical strength of tablet can be determined by its hardness and through friability test. In friability test the tablets are prone to abrasion hence enabling us to check for the tablet strength under application of force in different manner.

2. SCOPE

Friction and shock are the forces that most often cause tablets to chip, cap or break. The friability test is closely related to tablet hardness and is designed to evaluate the ability of the tablet to withstand abrasion in packaging, handling and shipping.

3. RESPONSIBILITIES

- It is the responsibility of designated personnel in Research lab to train staff and students on this procedure and to ensure adherence to this procedure.
- It is the responsibility of designated personnel (staff or Student) to follow the instructions of this procedure.

4. REFERENCES

- Instruction Manual (Operation Guide) – Tablet Friability-/Abrasion Testing, TAR 200, Erweka, Germany
- British Pharmacopoeia 2009 Vol 4. London: The Stationary Office; 2009. P. A438-A439.

5. DEFINITIONS

- **Abrasion Drum:** Consists of standardized internal plastic baffles used to test the abrasion strength of the tablets.
- **Friability/Abrasion Tester:** Consists of a drive unit that rotates a transparent plastic drum at a standard rpm (rotation per minute)
- **Friability Test:** Provides a standardized, reproducible method for measuring the tendency of a tablet to chip or powder when subjected to the mechanical stresses of the manufacturing, packaging and transportation processes of the tablet.

6. PRECAUTIONS

- Please pay attention that no article of the clothing or long hair will come into the rotating drum or the drum shaft
- Do not open the electrical compartment due to the risk of shock and allow only trained personnel to do so.
- When tightening the locking nut, ensure that it is not over tightened since this can cause damage to the drum.
- Do not use cleaning compounds containing ammonia or abrasive cleaners to clean the plastic drum since such compounds may damage plastic, causing it to crack and fracture.
- For tablets with a unit mass equal to or less than 650mg, a sample of tablets corresponding as near as possible to 6.5g is to be used whilst for tablets with a unit mass greater than 650mg, a sample of 10 whole tablets is to be used.
- According to the British Pharmacopoeia, 100 rotations are considered to be the standard number of rotations to be used for each test.
- According to the British Pharmacopoeia, a maximum loss of mass not greater than 1.0 per cent is considered acceptable for most types of tablets.

7. PROCEDURE FOR OPERATING THE AA SPECTROPHOTOMETER

Tablet Friability/ Abrasion Testing

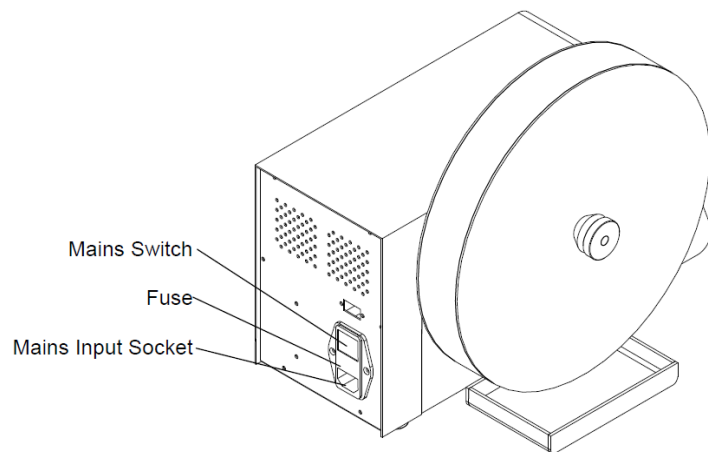
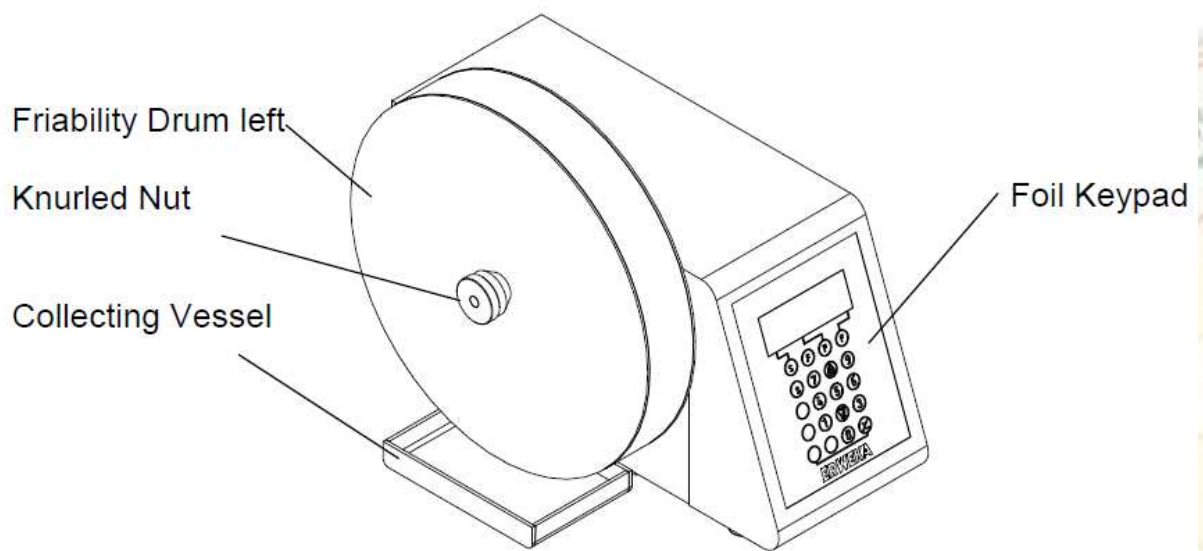

Switching on

- Switch the instrument on by means of the on/off switch located on the rear panel
- Before operation the instrument must be at the correct operation temperature. Switch-on the instrument approx. 10 minutes before starting a test

Touch-sensitive Keypad

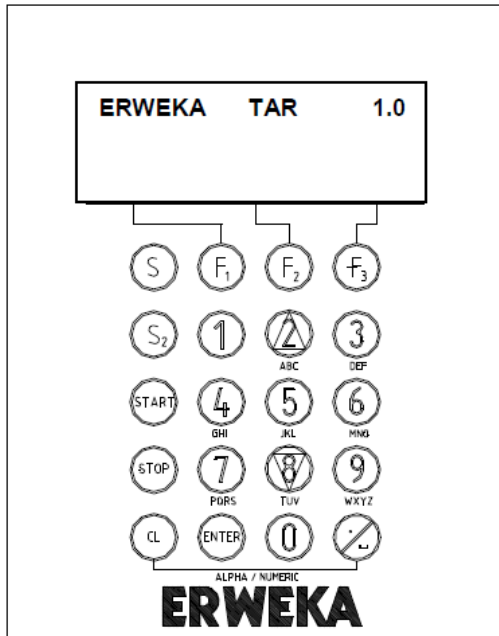

- Operation will be done by an alpha-numeric touch-sensitive foil-keypad with LCD display located in the front of the instrument.
- To enter figures following keys are available: $\square 0 \square - \square 9 \square$.
- The **F1**, **F2** and **F3** keys have the functions as indicated on the LCD-Display.
- A data input or confirmation will be completed with the \square Enter \square key.
- To correct actual settings in the input field move to the appropriate position with the <CL> key.
- All data inputs are supported by a beep tone. The beep tone confirms that the command has been accepted and carried out.

Test Run Time

- Two modes of operation are available either based on (a) time (hours, minutes and seconds) or (b) number of drum revolutions. Maximum time: 9 hours, 59 minutes, 59 seconds. Maximum revolutions: 99999.
- The pre-set time is permanently retained in the memory until a new time setting is input.
- Press key <F2> for G/T to adjust time mode or revolution mode.

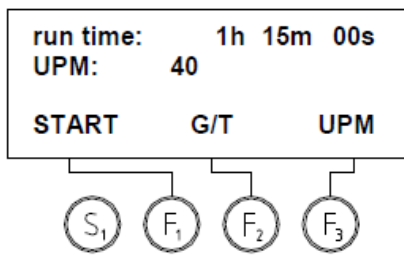

- Enter a test run time by means of the numeric keys starting with hours e.g. test run time is 1 hour, 15 minute. Press key <1> and confirm with <ENTER>.
- The current position being set is indicated by "blinking". Enter 15 and confirm with <ENTER>, enter the seconds and confirm with <ENTER>.

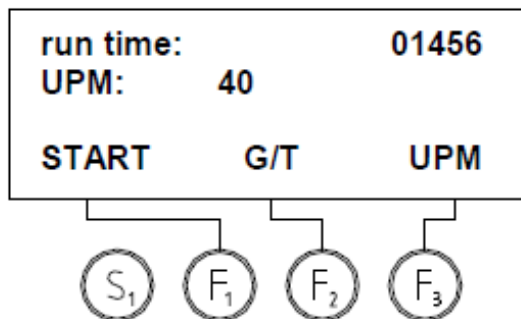

- Number of revolutions are entered by means of the numeric keys. Confirm the settings with <ENTER>.

RPM

- Driving speed is infinitely adjustable from 20 to 40 min⁻¹

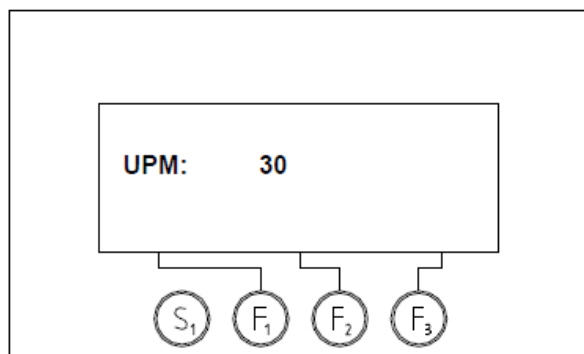

- Press key <F3> to adjust a speed value.
- Enter the requested speed by means of the numeric keys and press <ENTER> to confirm. The instrument returns to the main menu

Start

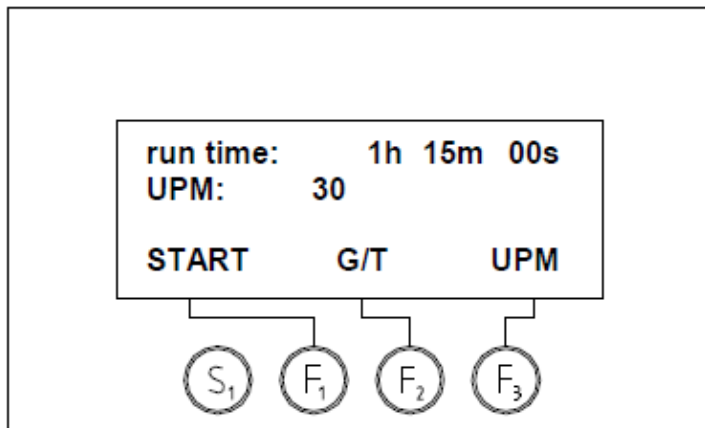

- Press key <F1> to start a test run.

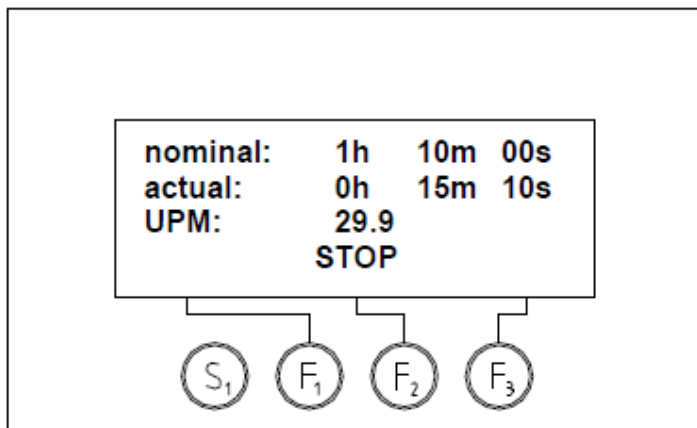

- Pre-set test run time (nominal), elapsed test run time (actual) and actual speed value are indicated on the display.
- Press key <F2> to stop a test run.

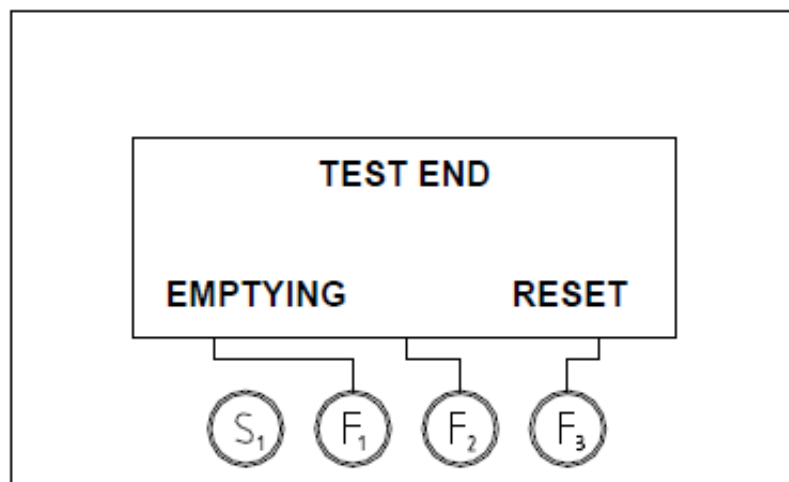

- On completion of the test run time the instrument stops.



- Press key <F1> to start the emptying function whereupon the drum runs three revolutions in reverse automatically emptying the contents of the drum into a collecting vessel.

Maintenance

- Routinely check drums for signs of cracks or chips.
- Inspect electrical connections for signs of corrosion and damage.
- Immediately wipe any spills from the exterior of the equipment using a moistened clean cloth.
- Clean drums thoroughly after each use using deionised water and dry with a soft cloth.

END OF DOCUMENT



21. SOP FOR TABLET THICKNESS TESTER

	Prepared by		
Document Number	Name	Signature	Date
CCP021	Dr. Sree Harsha Assistant Professor, Department of Pharmaceutical Sciences, College of Clinical Pharmacy, KFU		
Revision Number	Approved by		
R0	Dr. Arshia Shariff Asst. Professor , Department of Pharmaceutical Sciences, College of Clinical Pharmacy, KFU		

Document History

Document Section	Details of Amendments	Date	Modified by (Initials)
SOPs -	First Draft on SOP for the operation of TBH 250WTD for thickness	/ /2011	Dr. Harsha

1. OBJECTIVE

Thickness is one of the main control features of a tablet press, the other is weight control and speed. A tablet that is too thick may not fit into the counting device, a tablet that is too thin may break, Tablet thickness is a critical attribute and should be controlled with accuracy

2. SCOPE

Thickness is an important physical attribute. On the press thickness variation may mean there is a variation in weight and hardness or both.

3. RESPONSIBILITIES

- ❖ It is the responsibility of designated personnel in Research lab to train staff and students on this procedure and to ensure adherence to this procedure.
- ❖ It is the responsibility of designated personnel (staff or Student) to follow the instructions of this procedure.

4. REFERENCES

Nil

5. DEFINITIONS

Nil

6. PRECAUTIONS

Nil

7. PROCEDURE FOR OPERATING THE TABLET THICKNESS TESTER**AVERAGE WEIGHT OF A TABLET:**

- Check the cleanliness of the balance.
- Collect Sample of 20 tablets.
- Weigh the tablets, record the weight in BMR.
- Calculate the average weight of tablet.
- Calculate the mean (average weight of tablets) of average weight of each in Process check.

CHECKING OF INDIVIDUAL WEIGHT VARIATION:

- Collect sample of 20 tablets.
- Weigh the tablets, record the weight in BMR.
Calculate the average weight of tablet.
- Weigh 20 individual tablets one by one and record the observations in the BMR individually.



- Check the lower weight and upper weight for determination of lower and upper percentage deviation.
- Upper % deviation = (Average weight of 20 tablets – Upper weight)x100/Average weight of 20 tablets
- Lower % deviation = (Average weight of 20 tablets – Lower weight) x 100/Average weight of 20 tablets
- After checking initial parameters, if it is within the limit, compression machine can be started.

ABBREVIATIONS:

- BMR : Batch Manufacturing Record

END OF THE DOCUMENT



22. SOP FOR TABLET THICKNESS, WEIGHT, DIAMETER AND HARDNESS TESTER

	Prepared by		
Document Number	Name	Signature	Date
CCP022	Dr. Sree Harsha Assistant Professor, Department of Pharmaceutical Sciences, College of Clinical Pharmacy, KFU		
Revision Number	Approved by		
R0	Dr. Arshia Shariff Asst. Professor, Department of Pharmaceutical Sciences, College of Clinical Pharmacy, KFU		

Document History

Document Section	Details of Amendments	Date	Modified by (Initials)
SOPs -	First Draft on SOP for the operation of TBH 250WTD for weight variation	/ /2011	Dr. Harsha

1. OBJECTIVE

A tablet is designed to contain a specific amount of drug in a specific amount of tablet formula. As a check that a tablet contains the correct amount of drug, tablet weight, thickness, hardness is routinely measured. Inconsistent tablet weights are caused by mechanical problems with the tablet press such as incorrect operation of the punches, improper feed of granules into the die cavity, and incorrect tablet press speed.

2. SCOPE

TBH 250WTD: Applicable to determination of weight, diameter, hardness and thickness of a tablet during in process checking

3. RESPONSIBILITIES

- ❖ It is the responsibility of designated personnel in Research lab to train staff and students on this procedure and to ensure adherence to this procedure.
- ❖ It is the responsibility of designated personnel (staff or Student) to follow the instructions of this procedure.

4. REFERENCES

Instruction Manual Tablet Hardness Tester Type: TBH 250

5. DEFINITIONS

Nil

6. PRECAUTIONS

- ❖ During the test, parts of the body like fingers etc. can be squeezed between the movable test jaw and fixed jaw.
- ❖ Please put in the samples by tweezers or a similar tool.
- ❖ To remove remaining tablet debris use the supplied brush.
- ❖ During breaking the test samples fragments of the samples can spring off. Use only protective glasses

7. PROCEDURE FOR OPERATING THE AA SPECTROPHOTOMETER

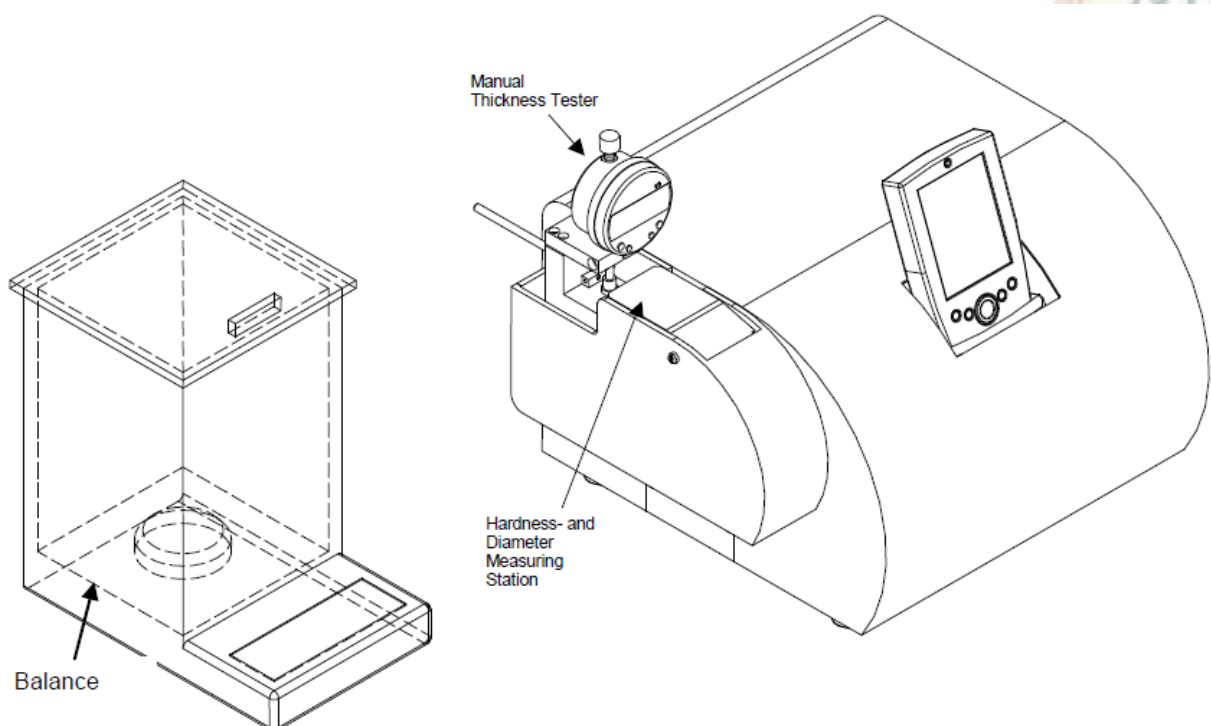



General view of Handheld Control Unit (HCU)

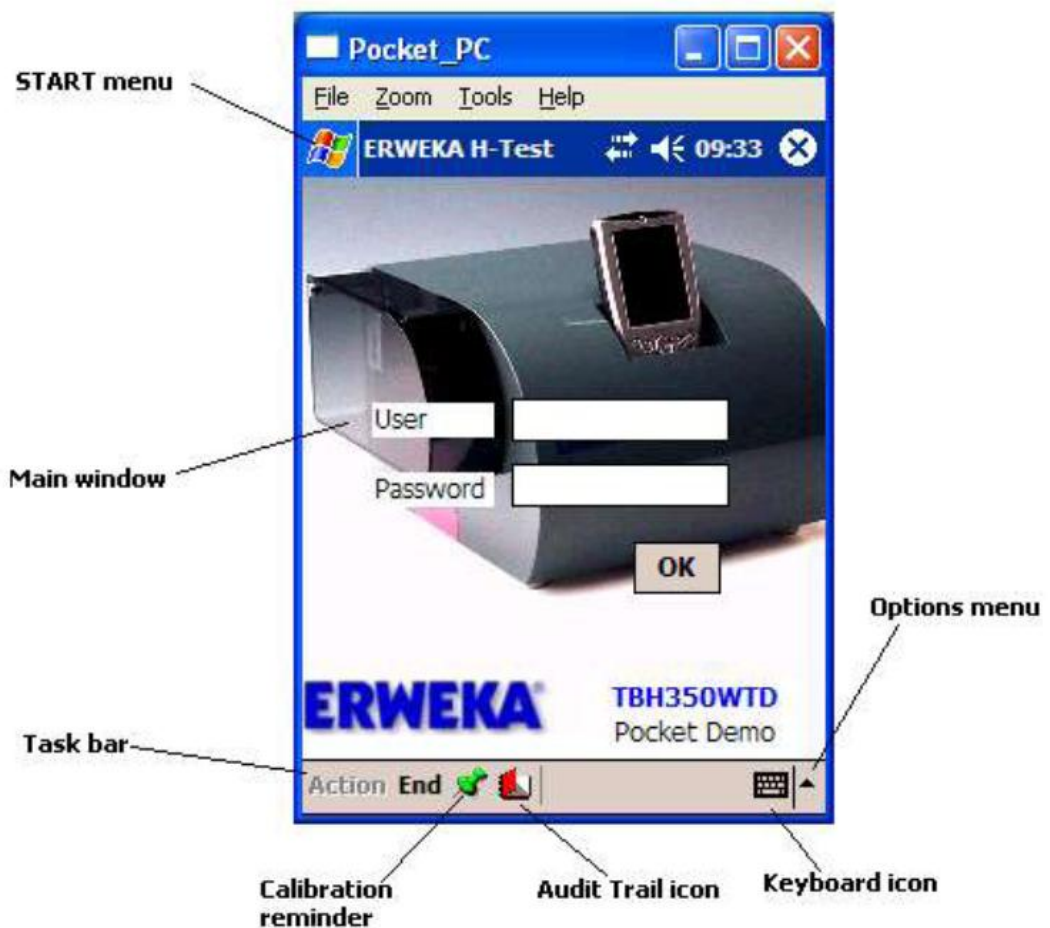

window



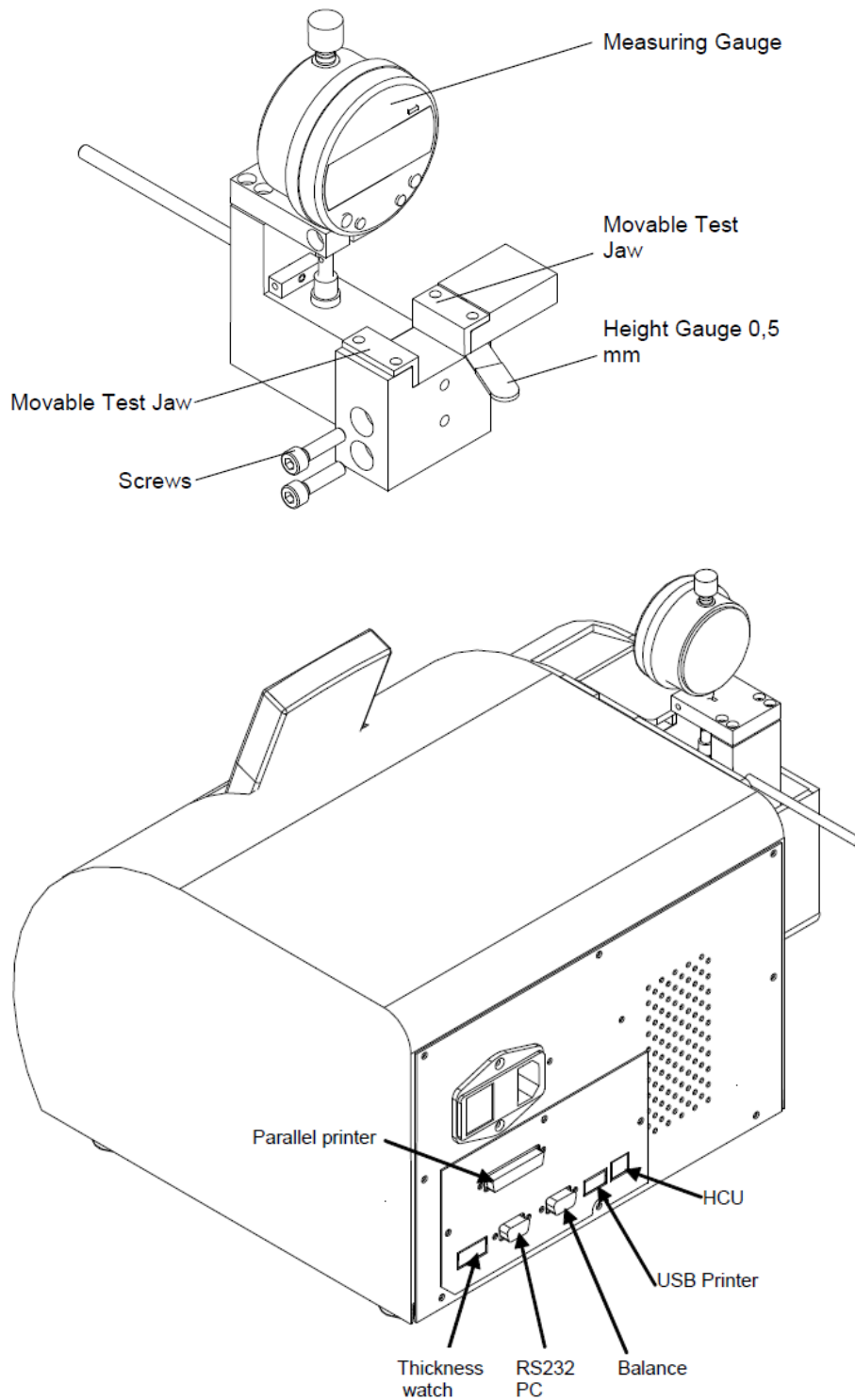

New measurements

- A new measurement is a test you conduct on a product that has not been tested on the instrument yet nor has it been created in the database (*see Operating Manual - Product Management*).

- Thus you have to first enter the information about the product and only then perform needed measurement tests.

Switching on the instrument

Power up the instrument by means of the mains switch on the rear side of the instrument.

When you log in to the instrument for the first time, use the following details: user admin and password abc123

To perform a new measurement:

1. Log in to the instrument.
2. Tap **Action, Measurement, New**. The following window appears:

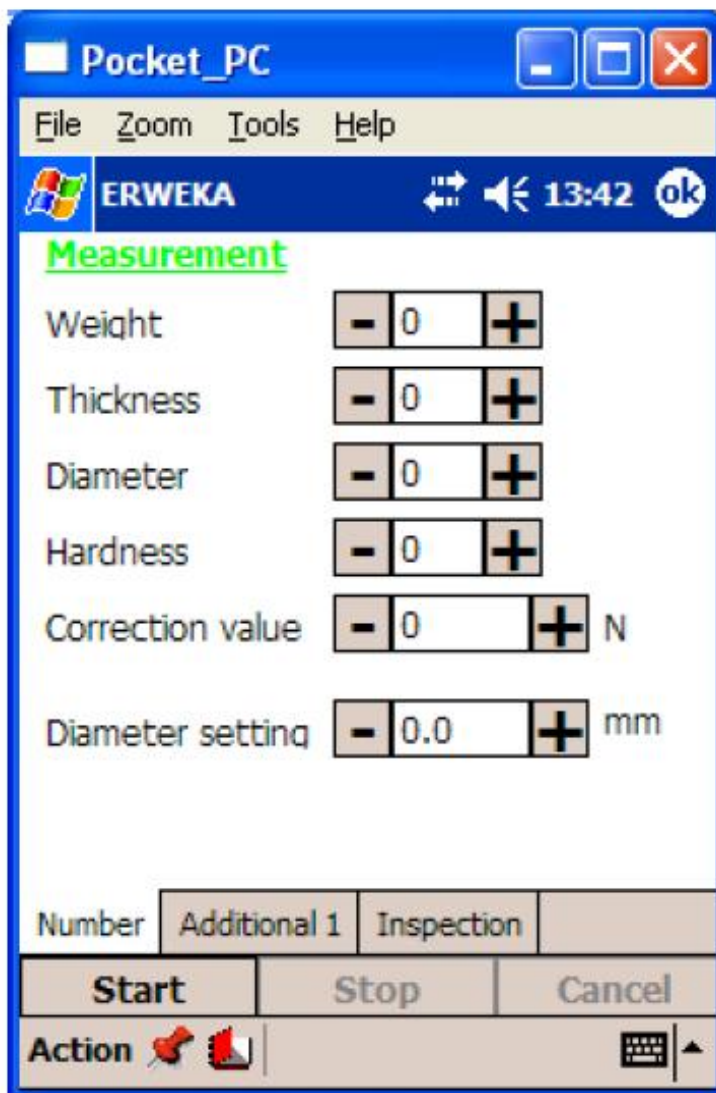

(operating Manual)

NOTE You may test not more than 100 tablets during one test run. If you enter a value out of the range of 1-100, the following message will appear:

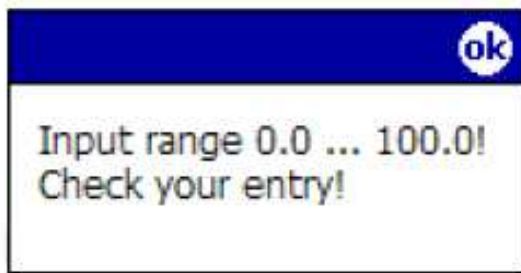

Check that the information you have provided so far is correct and then tap the **Inspection** tab. The following window appears:



- Place the product sample to measure weight and tap **Start**. Wait till the measurement is done. The value will appear in the **Weight** field. Now the window can look as follows:



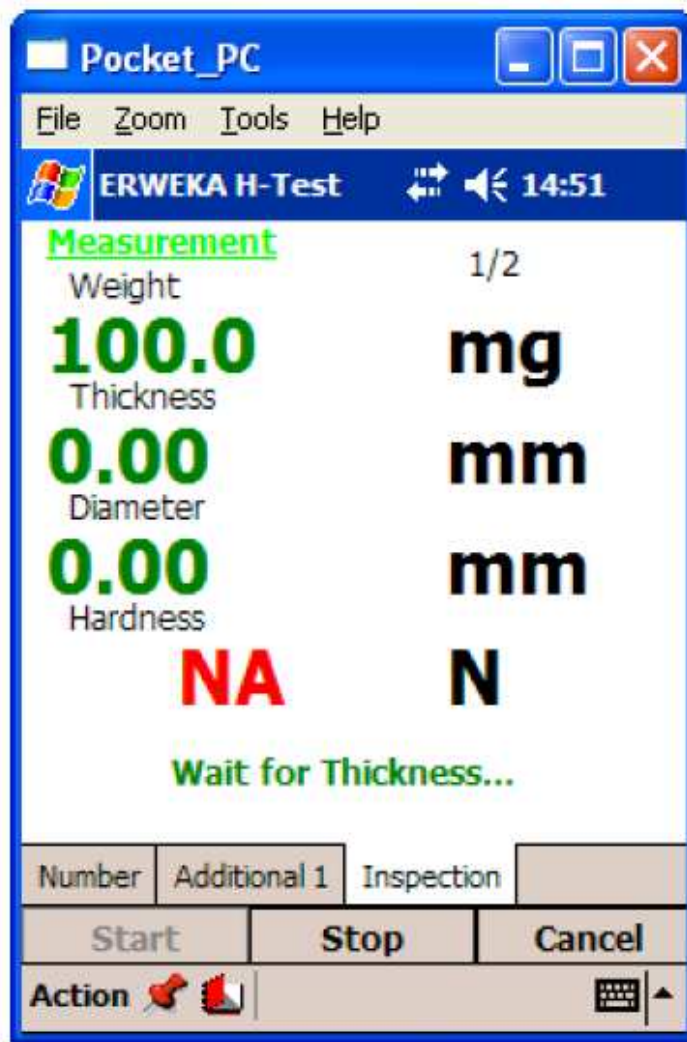

INFO If no measuring value for weight or thickness measurements has been transferred within the request period, the EE error message appears and you will be prompted to repeat the measurement.

- Place the product sample to measure thickness. Wait till the measurement is done. The value will appear in the **Thickness** field. Now the window can look as follows:

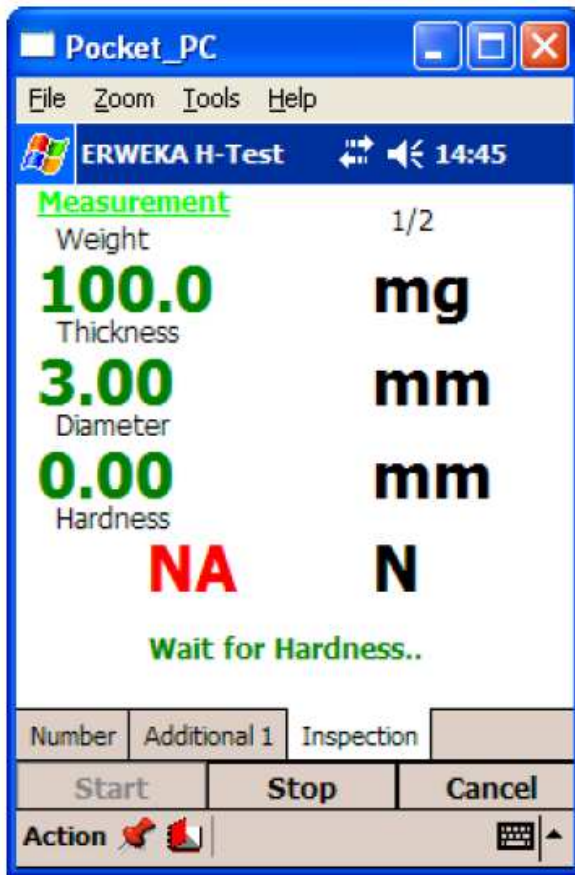

- Place the product sample to measure diameter. Wait till the measurement is done. The value will appear in the **Diameter** field. Now the window can look as follows:
- Place the product sample to measure hardness. Wait till the measurement is done. The value will appear in the **Hardness** field. After all the measurements have been done, the window may look as follows:



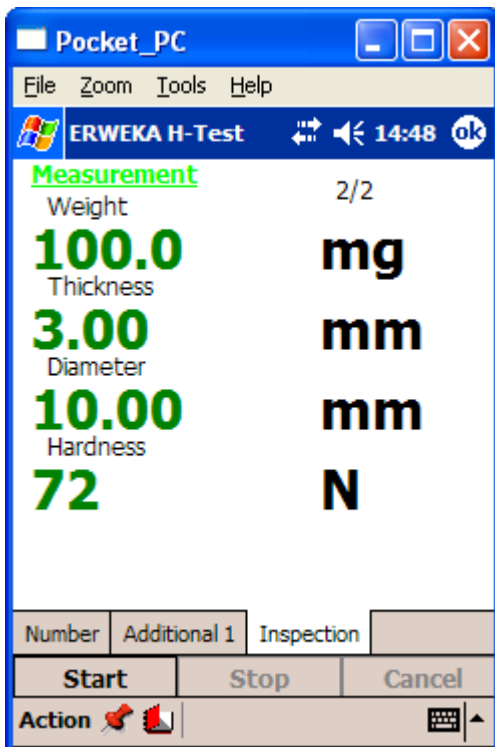

- Then a message appears asking you whether you want to print the results. Tap OK to print. Tap No to reject

INFO To stop the test at any time, tap the Stop button in the window. You can continue the test later. If you want to abort the test, tap Cancel.

INFO If the nominal value for the measuring parameter diameter is set too low, NA appears in the protocol after the measuring result.

INFO You can print measurement test results after the measurement. See Reports for more details.

Cleaning

- To guarantee the disturbance-free operation of the instrument, it is recommended to clean the instrument daily.
- To avoid adulterated measuring results, clean the fixed and movable test jaws from remaining tablet pieces.

!!! Do not use any detergents.

END OF DOCUMENT

23. SOP FOR TAPPED DENSITY TESTER

	Prepared by		
Document Number	Name	Signature	Date
CCP023	Dr. Sree Harsha Assistant Professor, Department of Pharmaceutical Sciences, College of Clinical Pharmacy, KFU		
Revision Number	Approved by		
R0	Dr. Arshia Shariff Asst. Professor, Department of Pharmaceutical Sciences, College of Clinical Pharmacy, KFU		

Document History

Document Section	Details of Amendments	Date	Modified by (Initials)
SOPs -	First Draft on SOP for the operation of Tapped Density Tester, SVM 202	/ /2011	Dr. Harsha

1. OBJECTIVE

The tapping action is generated by a rotating eccentric camshaft which lifts the platform and allows it to drop back to its original position..

2. SCOPE

Applicable to the Tapped Density Tester in Quality Control Department.

3. RESPONSIBILITIES

- ❖ It is the responsibility of designated personnel in Research lab to train staff and students on this procedure and to ensure adherence to this procedure.
- ❖ It is the responsibility of designated personnel (staff or Student) to follow the instructions of this procedure.
- ❖ Each side of the dual Tapped Density Tester is calibrated to the corresponding platform. Ensure the correct platform is placed into the proper sleeve (left and right).

4. REFERENCES

Instruction Manual (Operation Guide) - Tapped Density Tester, SVM 202, Erweka, Germany

5. DEFINITIONS

The Tapped Density Tester provides a standardized, reproducible method for measuring the tapped or bulk density of powdered, granulated, or flaked materials

6. PRECAUTIONS

- ❖ The Tapped Density Tester produces excessive noise levels. During operation consider wearing approved hearing protection devices or operating the unit in the optional acoustic cabinet
- ❖ Operation of a Tapped Density Tester involves the use of solids and powders. Unskilled, improper, or careless use of this instrument can create shock hazards.

7. PROCEDURE FOR OPERATING THE AA SPECTROPHOTOMETER

Dual-platform Tapped Density Tester



- ❖ Check that all the connections of the instrument are proper.
- ❖ Weigh the sample & fill in a measuring cylinder of Tapped Density Tester.
- ❖ Fix the measuring cylinder into the holder provided for holding the measuring cylinder on the instrument.
- ❖ Power “ON” the instrument.
- ❖ Select the mode of operation, either timer or counter, by pressing **TIME COUNT**. This key toggles the unit between the two operating modes. The Timer LED



illuminates to indicate the timer option is selected. The Counter LED illuminates to indicate the counter option is selected.

- ❖ Enter either the number of taps (up to 999,999) or the time duration (in hh:mm:ss format) as applicable and press **ENTER**. Once entered, the test duration is saved by the unit and does not need to be reset unless you want to change it. To change the duration, enter the new value and press **ENTER**.
- ❖ Pass the product through a number 18 sieve (1.00 mm sieve opening), if appropriate, and weigh the product for each cylinder separately. Step 5. Load the product into the cylinders and level it without compacting, if necessary.
- ❖ Press **START STOP** to begin. The time duration or number of taps count down on the display screen and the test stops automatically when 0 is reached. The display automatically resets to the original set value preparing the instrument for the next test.
- ❖ To calculate the tapped density, use the following equation:

$$\text{tapped density} = \frac{\text{initial weight}}{\text{final volume}}$$

Stopping a Test

When running a test on a Tapped Density Tester, you can stop the test by pressing **START STOP**. The cylinders stop immediately and the display returns to the original test length setting.

END OF DOCUMENT



24. SOP FOR THERMAL CYCLER (PCR)

	Prepared by		
Document Number	Name	Signature	Date
CCP024	Dr. Promise Emeka Assistant Professor, Department of Pharmaceutical Sciences, College of Clinical Pharmacy, KFU		
Revision Number	Approved by		
R0	Dr. Ibrahim Alhaider Dean, Department of Pharmaceutical Sciences, College of Clinical Pharmacy, KFU		

Document History

Document Section	Details of Amendments	Date	Modified by (Initials)
SOPs -	First Draft on SOP for the operation of TC-412 Thermal Cycler (PCR)	01/12/2011	Dr. Emeka

1. OBJECTIVE

- ❖ The following document describes the procedure on the operation of TC-412 Thermal Cycle (PCR).

2. SCOPE

- ❖ The following procedure applies to designated personnel in Research laboratory.
- ❖ PCR is a technique that allows Research Scientists to create or amplify a vast quantity of a specific sequence of DNA.

3. RESPONSIBILITIES

- ❖ It is the responsibility of designated personnel in Research lab to train staff and students on this procedure and to ensure adherence to this procedure.
- ❖ It is the responsibility of designated personnel (staff or Student) to follow the instructions of this procedure.
- ❖ It is important that only trained personnel are allowed to operate this equipment.

4. REFERENCES

- ❖ TC-412 Instruction Manual (Operator's Manual).
- ❖ Programming Procedure for TC-412 Thermal Cycler for use.

5. DEFINITIONS

- ❖ PCR: *Polymerase Chain Reaction*
- ❖ DNA: Deoxyribonucleic Acid



6. PRECAUTIONS

- ❖ Lab coat, and hand gloves must be worn when preparing samples for the PCR
- ❖ When using the machine, hand gloves must be removed during the operation of the machine.
- ❖ All chemicals used as reagents in PCR reaction must have safety storage procedure.
- ❖ There is a risk of burns if the PCR block is inadvertently touched when hot.
- ❖ Clean machine after use if there has been sample spillages by wiping with a damp soapy cloth.
- ❖ While cleaning, care should be exercised to prevent water from entering the inside the unit.
- ❖ Before cleaning, always disconnect the power supply and allow machine to cool below 50⁰C.
- ❖ Do not use abrasive cleaners.
- ❖ The key pad must not be pressed with sharp objects such as pens, pencils, and finger nails as will cause damage.

7. PROCEDURE FOR OPERATING THE TC-412 THERMAL CYCLER (PCR) MACHINE.

Turning on the PCR machine

- ❖ Switch on the machine at the rear with symbols: I mains switch ON and O mains switch OFF
- ❖ The machine will then display the opening four line display.

- ❖ The top three lines are information or program lines, while the bottom line is the prompt line.
- ❖ The prompt figure in the line will flash.
- ❖ The arrow keys will indicate selection of $\uparrow\downarrow$ while \leftarrow indicates delete
- ❖ This arrow key  indicates enter and is used to enter operation or edit mode. It is also used to accept a field or program change.
- ❖ The symbol  is the end key.
- ❖ To into programs which will be flashing, press Enter.
- ❖ This will show a screen for new program with Templates.
- ❖ Copy a template and create a new program.
- ❖ Use the arrows to set the conditions for running your samples
- ❖ Use the End key to save your settings

Running samples

- ❖ Reaction volumes between 20-200 μ l must be used and tubes used must be able to withstand a pressure of 1 atmosphere at 100⁰ C.
- ❖ All reagents and samples must be in ice before and after cycling.
- ❖ Use arrow keys to select the program you want to run.
- ❖ Duration of run will show on the screen
- ❖ Machine will turn-off automatically at the end of selected no of cycles
- ❖ If you need to run samples overnight, please inform the Technologist in-charge.

To turn off the instrument.

- 7.4.1. Switch off after use by switching to O at the back.

If you experience any problems during the use of this equipment, please report to the Technologist in-charge immediately.

End of Document

25. SOP FOR ZETASIZER

	Prepared by		
Document Number	Name	Signature	Date
CCP025	Dr. Azza Ali Hasan Assistant Professor, Department of Pharmaceutical Sciences, College of Clinical Pharmacy, KFU		
Revision Number	Approved by		
R0	Dr. Ibrahim Alhaider Dean, Department of Pharmaceutical Sciences, College of Clinical Pharmacy, KFU		

Document History

Document Section	Details of Amendments	Date	Modified by (Initials)
SOPs -	First Draft on SOP for the operation of Zetasizer	/ /2011	Dr. Azza

1. OBJECTIVE

The following document describes the procedure on the operation of Zetasizer.

2. SCOPE

The Zetasizer measures particle and molecular size from below a nanometer to several microns, zeta potential, electrophoretic mobility, and molecular weight. Zetasizer is used for

- ❖ Determination of optimum dispersion conditions for a wide range of applications.
- ❖ Stabilization/destabilization of suspensions, dispersions and emulsions via electrostatic stabilization mechanisms.
- ❖ Determination of critical coagulation concentrations, sensitivity to the concentration of additives, such as salts, surfactants, polymers.
- ❖ Estimation of adsorbed polymer layer thickness.
- ❖ Optimizing surface coatings, effect of surface modifications
- ❖ Biological applications, characterization of erythrocytes and blood platelets, characterization of cells, bacteria etc

3. RESPONSIBILITIES

- ❖ It is the responsibility of designated personnel in Research lab to train staff and students on this procedure and to ensure adherence to this procedure.
- ❖ It is the responsibility of designated personnel (staff or Student) to follow the instructions of this procedure.

4. REFERENCES

Instruction Manual (Operation Guide) Malvern company for Zetasizer **MAN0317ISUE 2 . 1 JULY2004.**

5. DEFINITIONS

- ❖ The particle size measured in a DLS instrument is the diameter of the sphere that diffuses at the same speed as the particle being measured. The Zetasizer system determines the size by first measuring the Brownian motion of the particles in a sample using Dynamic Light Scattering (DLS) and then interpreting a size from this using established theories.
- ❖ Brownian motion is defined as: “The random movement of particles in a liquid due to the bombardment

6. PRECAUTIONS

- ❖ Failure to follow these guidelines could result in exposure to hazardous voltages and laser radiation.
- ❖ The system is capable of heating the cell to high temperatures. Care should be taken when removing the cells if a measurement has been performed at high temperatures. It is recommended that the cell area is allowed to cool before removing the cell. A **warning triangle** is provided in the cell basin.
- ❖ Due to the risk of melting, polystyrene cuvettes must not be used for measurements above 50°C.

7. PROCEDURE FOR OPERATING of Zetasizer

7.1. SOP measurements. A Standard Operating Procedure (SOP) is like a template that pre-defines all the measurement settings. This ensures that measurements made on the same type of sample are made in a consistent way. SOPs are ideal if the same type of sample is regularly measured, inputting the same parameters each time a measurement is made is tedious and runs the risk of making errors. SOPs can be created or modified as required.

To perform an SOP measurement, select Measure-Start SOP from the menu bar and select an SOP to use. With an SOP chosen the Measurement display will appear (below). The measurement will begin by pressing the Start (_) button.

7.2. Manual Measurement.

- ❖ Close the lid and Turn on the instrument and wait 30 minutes for the laser to stabilize.
- ❖ Start the Zetasizer software.
- ❖ Prepare the sample following the sample preparation guidelines.
- ❖ Choose the cell(s) appropriate for the sample and measurement type.
- ❖ Fill the cell(s) with the prepared sample.
- ❖ Make an SOP measurement.
- ❖ If necessary Open or create a new measurement file.
- ❖ Select Measure-Start SOP from the Zetasizer software.
- ❖ Select the SOP required and select Open.
- ❖ Follow any onscreen instructions that appear.
- ❖ The Measurement display will now be shown.
- ❖ When requested, insert the cell into the instrument and wait for the temperature to stabilize.
- ❖ Click Start (_). The measurement will be made and the results displayed and saved to the open measurement file.

7.3. Software Operation.

❖ Menu bar.

The menu bar contains the main menu headings for all software functions. Items which end with a row of dots (...) will cause dialogue boxes to appear. Similarly any items which end with an arrow (_) will cause a second menu to appear.

Items that are shown in grey indicate that they are not available. Grey items indicate that some security setting has been activated, or that the item is not relevant to the system connected.

❖ File Menu:

The File menu is used to Open... or create a New measurement file. The measurement file is where all the measurement records (results) will be stored. Select Save as... to store a measurement file under a different file name. Once a measurement file has been created, use Export ... to export the measurement details to other software packages such as Excel or Wordpad. Select Batch print... to simultaneously print a number of measurement records.

Create PDF... is only enabled if the 21 CFR part 11 feature key has been installed. As a shortcut, a list of the most recently used measurement files are shown at the bottom of the menu for immediate opening.

❖ **Edit Menu**

Allows movement and manipulation of records in the Measurement file window(s). Records can be cut, copied, pasted and deleted into their own or other measurement files.

Edit result... allows an existing measurement record to be reanalyzed using different dispersant and particle properties. Comments on the editing reason added. The edited measurement will then be added to the bottom of the Records view listing. To view the settings for any particular measurement record, select the record and then Extract SOP.... The SOP dialogues will appear showing the original measurement settings. These can then be saved as an SOP so measurements can be made again with the same settings. This is useful if the parameters of the measurement record are not already saved in the SOP directory.

❖ **View Menu:**

This selects which reports will be shown in the measurement file window and which Toolbars are to be displayed. Workspaces will select the workspace toolbar, and which measurement workspace is to be displayed. The reports available are those selected when creating the workspace with the Configure-Workspace dialogues. The reports available will change to match the workspace chosen. Select Status bar to toggle the status bar from being displayed or not.

❖ **Configure Menu**

Use this menu to create or edit the measurement settings in an SOP prior to performing the measurement. New SOP... opens the SOP creation wizard, while Existing SOP... allows a previously created SOP to be altered.

❖ **Measure Menu**

Select this menu when ready to perform a measurement. There is a choice of using an existing measurement SOP or manually setting up the measurement and sample details. Once the measurement details have been entered or an SOP has been chosen, the Measurement display will appear.

❖ **Tools Menu:**

With this tool estimates of the Molecular weight and particle shape can be generated.

Instrument allows access to the manual controls of the instrument or each connected accessory. Serial port... allows the USB communications port to which the instrument is

connected to be chosen. MPT-2 Titrator allows access to the manual control dialogues of the MPT-2 Autotitrator. This menu item will be 'greyed' out if the MPT-2 is not connected. Engineering allows Malvern authorized service engineers to perform maintenance tasks. The engineering screens are password protected.

End of Document





TAKEN BY : ALI ALMERZA

**King Faisal University
College of Clinical Pharmacy
PO Box 400, Al-Ahsa:31982**

**Phone: 00966-3-5817175,
00966-3-5800000, Extn:1783**

Fax: 00966-3-5817174

E-mail: clinicalpharmacy@kfu.edu.sa